

# h3+

Moulded Case  
Circuit Breakers  
up to 250 A

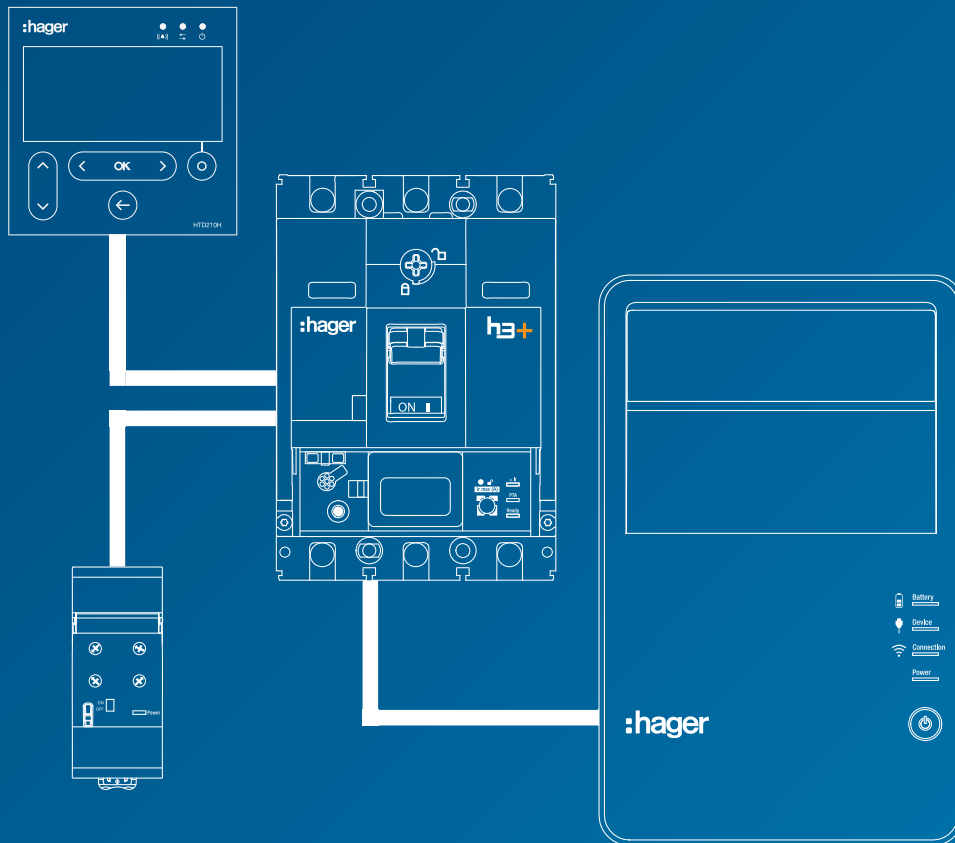



# Index

Page

---

<b>01 About this manual</b>	<b>5</b>
1.1 Safety advice	6
1.2 Using this manual	8
1.3 Abbreviations	9

---

<b>02 Description of the h3+ communication system</b>	<b>11</b>
2.1 h3+ electronic trip units	12
2.2 h3+ communication system	19
2.3 HTP610H h3+ configuration tool	20
2.4 HTD210H panel display	22
2.5 Modbus communication module	23
2.6 Energy AX/AL auxiliary	24

---

<b>03 Function of the Energy trip unit</b>	<b>25</b>
3.1 Energy trip unit navigation and settings	26
3.2 Protection function	31
3.3 Measurement function	41
3.4 Managing alarms and logs	60

---

<b>04 Starting, commissioning, operation</b>	<b>73</b>
4.1 Plug connections and accessories	74
4.2 Starting and configuring the circuit breaker	76
4.3 Connecting the communication module	86
4.4 Assembling and connecting the Energy AX/AL auxiliary	89
4.5 Connecting the PTA and OAC output contacts	91
4.6 Start-up and configuration via the HTD210H display	93
4.7 Commissioning via the HTP610H configuration tool	104
4.8 Operation	112

---

<b>05 Communication via Modbus</b>	<b>117</b>
5.1 Modbus functionalities of the Energy circuit breaker	118
5.2 Write protection and managing Modbus passwords	119
5.3 Connecting the communication module to the Modbus network	120
5.4 Configuring the Modbus communication module	122
5.5 Communication with agardio.manager	125

---

<b>06 Support</b>	<b>125</b>
6.1 Troubleshooting	<b>126</b>

---



# About this manual

	<b>Page</b>
<b>1.1 Safety advice</b>	<b>6</b>
<b>1.2 Using this manual</b>	<b>8</b>
<b>1.3 Abbreviations</b>	<b>9</b>

### Warnings and instructions

This documentation contains safety advice which must be respected for your own safety and to prevent property damage.

Safety advice relating to your own safety is identified by a safety warning symbol in the documentation. Safety advice relating to damage to property is identified by "ATTENTION".

The safety warning symbols and the wording below are classified according to the risk level.



**DANGER** indicates an imminent dangerous situation which, if unavoids, will result in death or serious injuries.



**WARNING** indicates a potentially dangerous situation which, if unavoids, may result in serious injuries or even death.



**IMPORTANT** indicates a potentially dangerous situation which, if unavoids, may result in minor or moderate injuries.



**ATTENTION** indicates a warning message relating to equipment damage. **ATTENTION** also indicates important instructions for use and particularly relevant information regarding the product, which must be respected to ensure effective and safe use.

**Qualified personnel**

The product or the system described in this documentation must be installed, operated and maintained by qualified personnel only. Hager Electro accepts no responsibility regarding the consequences of this equipment being used by unqualified personnel.

Qualified personnel are those people who have the necessary skills and knowledge for building, operating and installing electrical equipment, and who have received training enabling them to identify and avoid the risks incurred.

**Appropriate use of Hager products**

Hager products are designed to be used only for the applications described in the catalogues and on the technical documentation relating to them. If products and components from other manufacturers are used, they must be recommended and approved by Hager.

Appropriate use of Hager products during transport, storage, installation, assembly, commissioning, operation and maintenance is required to guarantee problem-free correct operation in complete safety.

The permissible ambient conditions must be respected. The information contained in the technical documentation must be respected.

**Publication liability**

The contents of this documentation have been reviewed in order to ensure that the information is correct at the time of publication.

Hager cannot, however, guarantee the accuracy of all the information contained in this documentation. Hager assumes no responsibility for printing errors and any damage they may cause.

Hager reserves the right to make the necessary corrections and modifications to subsequent versions.

**Purpose of the document.**

This manual is designed to provide users, electricians, panel builders and maintenance personnel with the technical information required for commissioning and operating h3+ circuit breakers with electronic trip units as well as their communicating accessories.

**Field of application**

This document is applicable to h3+ LSnl, LSI, LSIG and Energy circuit breakers with electronic trip units.

**Application note**

This manual is intended for:

- Electricians and panel builders
- maintenance service personnel

**Revisions**

Version	Date
6LE005550A version zero	September 2018

**Documents to consult**

Document	Reference
h3+ Modbus communication table	6LE005605A
HTD210H panel display user manual	6LE002999A
HTP610H configuration tool user manual	6LE005546A
Agardio Manager user manual	6LE001606B

You can download these publications and other technical information from our website: [www.hager.fr](http://www.hager.fr)

**Contact**

Address	Hager Electro SAS 132 Boulevard d'Europe 67215 Obernai France
Telephone	+ 33 (0)3 88 49 50 50
+ 33 (0)3 88 49 50 50 Website	<a href="http://www.hager.fr">www.hager.fr</a>



<b>ACP</b>	Auxiliary Communication Port: Connector for the AX/AL Energy auxiliary
<b>AL</b>	ALarm: Fault-signal auxiliary contact
<b>AX</b>	AuXiliary: Open/closed auxiliary contact
<b>CIP</b>	Communication Interface Port: Connector for the panel display and communication module
<b>MIP</b>	Maintenance Interface Port: connector for HTP610H configuration tool
<b>OAC</b>	Optional Alarm Contact: Connector for the optional alarm output contact
<b>PTA</b>	Pre-Trip Alarm: Overload pre-alarm and connector for the overload pre-alarm output contact
<b>LCD</b>	Liquid Crystal Display
<b>SSID</b>	Service Set Identifier (name of wireless Wi-Fi network)
<b>SELV</b>	Safety Extra Low Voltage
<b>URL</b>	Uniform Resource Locator (Internet website address)
<b>ZSI</b>	Zone Selective Interlocking (selectivity per zone).



# Description of the h3+ communication system

Page

---

<b>2.1 h3+ electronic trip units</b>	<b>12</b>
<b>2.1.1</b> LSnl trip units	13
<b>2.1.2</b> LSI trip units	14
<b>2.1.3</b> LSIG trip units	15
<b>2.1.4</b> Energy trip units	16
<b>2.1.5</b> Meaning of LEDs and alarm notifications	18

---

<b>2.2 h3+ communication system</b>	<b>19</b>
-------------------------------------	-----------

---

<b>2.3 HTP610H h3+ configuration tool</b>	<b>20</b>
<b>2.3.1</b> Field of application	20
<b>2.3.2</b> Energy trip unit test	20
<b>2.3.3</b> Accessing the h3+ configuration WEB pages	21

---

<b>2.4 HTD210H panel display</b>	<b>22</b>
<b>2.4.1</b> Presentation	22
<b>2.4.2</b> Characteristics of the HTD210H display	22

---

<b>2.5 Modbus communication module</b>	<b>23</b>
--	-----------

---

<b>2.6 AX/AL Energy auxiliary</b>	<b>24</b>
-----------------------------------	-----------

---

In addition to protecting against overloads and short-circuits, the h3+ moulded case circuit breakers equipped with electronic trip units provide great flexibility and fine-tuning capabilities for protection, improved selectivity values, and an extensive range of electrical measurements as well as communication functions.



Overview of electronic trip units

Four versions are available:

- LSnl
- LSI
- LSIG
- Energy

The h3+ moulded case circuit breakers with electronic trip units are equipped with PTA and MIP connectors to facilitate advanced use of the product.

	LSnl	LSI	LSIG	Energy
<b>PTA:</b> Overload pre-alarm connector	-	X	X	X
<b>MIP:</b> Connector for HTP610H	X	X	X	X

### PTA connector

The PTA connector, located on the side of the circuit breaker, enables an auxiliary signal circuit to be connected to the overload pre-alarm output contact. The threshold of this pre-alarm is set at 90% of the I<sub>r</sub> setting on LSI or LSIG versions and can be adjusted on the Energy version.



PTA connector

### MIP connector

The MIP connector on the front face is used to connect the HTP610H h3+ configuration tool in order to test the tripping of the circuit breaker, configure the trip unit parameters and perform diagnostics on the circuit breaker.



MIP connector

### 2.1.1 LSnl trip units

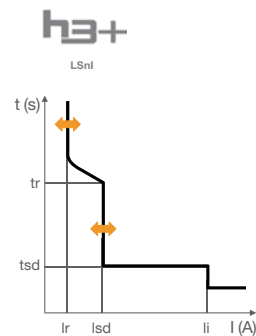
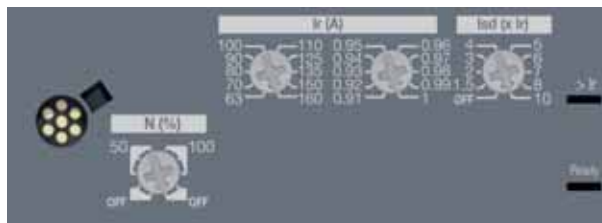

- Configuration using adjustment dials.
- Signalling the status of the trip unit via LED (Ready).
- Signalling the overload alarm via LED (>Ir).
- Possible adjustment of the threshold for the long time delay Ir and the short time delay current Isd. The tr and tsd parameters and the instantaneous trip parameters are fixed.
- Possible adjustment of the neutral pole protection on 4-pole versions (neutral positioned on the left).

	40 A	100 A	160 A	250 A
<b>P160</b>	X	X	X	-
<b>P250</b>	X	X	X	X

#### L - Long time delay protection

Ir (tripping between 1.05 and 1.20 x Ir)

Ir1 (A)	In = 40 A	16 - 18 - 20 - 22 - 25 - 28 - 32 - 34 - 37 - 40
Ir1 (A)	In = 100 A	40 - 45 - 50 - 57 - 63 - 72 - 80 - 87 - 93 - 100
Ir1 (A)	In = 160 A	63 - 70 - 80 - 90 - 100 - 110 - 125 - 135 - 150 - 160
Ir1 (A)	In = 250 A	90 - 100 - 110 - 125 - 140 - 160 - 180 - 200 - 225 - 250
fine adjustment Ir2		0.91 - 0.92 - 0.93 - 0.94 - 0.95 - 0.96 - 0.97 - 0.98 - 0.99 - 1

tr (accuracy -21%/+1%)

tr (s) at 6 x Ir	5 (fixed)
------------------	-----------

#### S - Short time delay protection

Isd (accuracy -10/+10%)

Isd adjustment = Ir x ...	OFF - 1.5 - 2 - 3 - 4 - 5 - 6 - 7 - 8 - 10
tsd (ms) at 10 x Isd	100 (fixed)
non-tripping time (ms)	80
maximum cut-off time (ms)	150

#### I - Instantaneous protection

li (accuracy +15/-15%)	15 x In (fixed)	11 x In (fixed)
time delay (ms)	fixed	
non-tripping time (ms)	10	
maximum cut-off time (ms)	50	

#### Neutral adjustment (4P only)

neutral protection (Ir, Isd) x ...	OFF - 50% - 100%
neutral protection li	Same as phases
time delay	Same as tr, tsd and instantaneous

2.1.2  
LSI trip units

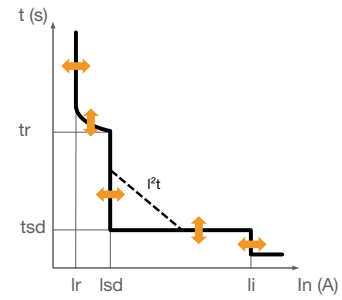
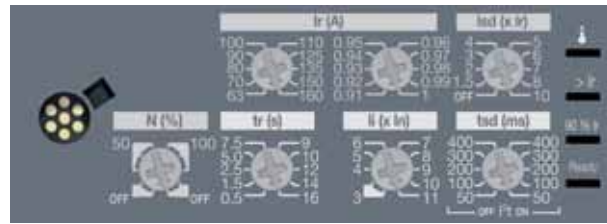

- Configuration using adjustment dials.
- Signalling the status of the trip unit via LED (Ready).
- Signalling the PTA overload pre-alarm via LED (threshold 90% Ir).
- Signalling the overload alarm via LED (>Ir).
- Signalling the trip unit temperature alarm via LED.
- Possible adjustment of time delays and thresholds. The instantaneous trip time is fixed.
- Possible adjustment of the neutral pole protection on 4-pole versions (neutral positioned on the left).

	40 A	100 A	160 A	250 A
<b>P160</b>	X	X	X	-
<b>P250</b>	X	X	X	X

**L - Long time delay protection**

Ir (tripping between 1.05 and 1.20 x Ir)

Ir1 (A)	In = 40 A	16 - 18 - 20 - 22 - 25 - 28 - 32 - 34 - 37 - 40
Ir1 (A)	In = 100 A	40 - 45 - 50 - 57 - 63 - 72 - 80 - 87 - 93 - 100
Ir1 (A)	In = 160 A	63 - 70 - 80 - 90 - 100 - 110 - 125 - 135 - 150 - 160
Ir1 (A)	In = 250 A	90 - 100 - 110 - 125 - 140 - 160 - 180 - 200 - 225 - 250
fine adjustment Ir2		0.91 - 0.92 - 0.93 - 0.94 - 0.95 - 0.96 - 0.97 - 0.98 - 0.99 - 1

tr (accuracy -21%/+1%)

tr (s) at 6 x Ir	0.5 - 1.5 - 2.5 - 5 - 7.5 - 9 - 10 - 12 - 14 - 16
------------------	---

**S - Short time delay protection**

Ird (accuracy -10/+10%)

Ird adjustment = Ir x ...	OFF - 1.5 - 2 - 3 - 4 - 5 - 6 - 7 - 8 - 10
tsd (ms) at 10 x Ir and I²t OFF	50 100 200 300 400
tsd (ms) at 10 x Ir and I²t ON	50 100 200 300 400
non-tripping time (ms)	20 80 180 280 380
maximum cut-off time (ms)	80 150 250 350 450

**I - Instantaneous protection**

Ii (accuracy +15/-15%)

In = 40 A; 100 A: Ii (x In)	3 - 4 - 5 - 6 - 7 - 8 - 10 - 12 - 15
In = 160 A; 250 A: Ii (x In)	3 - 4 - 5 - 6 - 7 - 8 - 9 - 10 - 11
time delay (ms)	fixed
non-tripping time (ms)	10
maximum cut-off time (ms)	50

**Neutral adjustment (4P only)**

neutral protection (I <sub>r</sub> , I <sub>sd</sub> ) x ...	OFF - 50% - 100%
instantaneous neutral protection I <sub>ii</sub>	Same as phases
time delay	Same as t <sub>r</sub> , t <sub>sd</sub> and instantaneous

**2.1.3  
LSIG trip units**

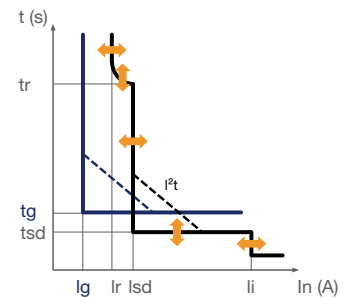
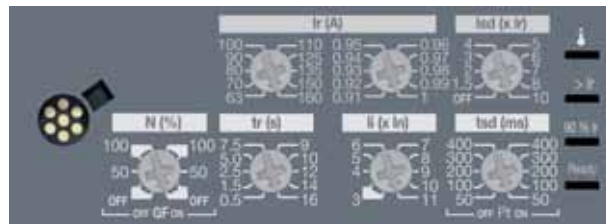

- Configuration using adjustment dials.
- Signalling the status of the trip unit via LED (Ready).
- Signalling the PTA overload pre-alarm via LED (threshold 90% I<sub>r</sub>).
- Signalling the overload alarm via LED (>I<sub>r</sub>).
- Signalling the trip unit temperature alarm via LED.
- Possible adjustment of time delays and thresholds. The instantaneous trip time is fixed. Ground protection: I<sub>g</sub> and t<sub>g</sub> fixed.
- Possible adjustment of the neutral pole protection on 4-pole versions (neutral positioned on the left).

	40 A	100 A	160 A	250 A
<b>P250</b>	X	X	X	X

**L - Long time delay protection**

I<sub>r</sub> (tripping between 1.05 and 1.20 x I<sub>n</sub>)

I <sub>r1</sub> (A)	I <sub>n</sub> = 40 A	16 - 18 - 20 - 22 - 25 - 28 - 32 - 34 - 37 - 40
I <sub>r1</sub> (A)	I <sub>n</sub> = 100 A	40 - 45 - 50 - 57 - 63 - 72 - 80 - 87 - 93 - 100
I <sub>r1</sub> (A)	I <sub>n</sub> = 160 A	63 - 70 - 80 - 90 - 100 - 110 - 125 - 135 - 150 - 160
I <sub>r1</sub> (A)	I <sub>n</sub> = 250 A	90 - 100 - 110 - 125 - 140 - 160 - 180 - 200 - 225 - 250
fine adjustment I <sub>r2</sub>		0.91 - 0.92 - 0.93 - 0.94 - 0.95 - 0.96 - 0.97 - 0.98 - 0.99 - 1

t<sub>r</sub> (accuracy -21%/+1%)

t <sub>r</sub> (s) at 6 x I <sub>r</sub>	0.5 - 1.5 - 2.5 - 5 - 7.5 - 9 - 10 - 12 - 14 - 16
--	---

**S - Short time delay protection**

I<sub>sd</sub> (accuracy -10%/+10%)

I <sub>sd</sub> adjustment = I <sub>r</sub> x ...	OFF - 1.5 - 2 - 3 - 4 - 5 - 6 - 7 - 8 - 10
t <sub>sd</sub> (ms) at 10 x I <sub>r</sub> and I <sup>2</sup> t OFF	50    100    200    300    400
t <sub>sd</sub> (ms) at 10 x I <sub>r</sub> and I <sup>2</sup> t ON	50    100    200    300    400
non-tripping time (ms)	20    80    180    280    380
maximum cut-off time (ms)	80    150    250    350    450

**I - Instantaneous protection**

$I_i$  (accuracy +15/-15%)

$I_n = 40 \text{ A}; 100 \text{ A}; I_i (x I_n)$	3 - 4 - 5 - 6 - 7 - 8 - 10 - 12 - 15
$I_n = 160 \text{ A}; 250 \text{ A}; I_i (x I_n)$	3 - 4 - 5 - 6 - 7 - 8 - 9 - 10 - 11
time delay (ms)	fixed
non-tripping time (ms)	10
maximum cut-off time (ms)	50

**G - Ground protection**

$I_g$  (accuracy +10/ -10%)

$I_g = I_n x \dots$	OFF - 40% for $I_n = 40 \text{ A}$ ; 20% for $I_n > 40 \text{ A}$
time delay (ms)	200 (fixed); $I^2t$ activated according to $I_{sd} I^2t$
non-tripping time (ms)	180
maximum cut-off time (ms)	250

**Neutral adjustment (4P only)**

neutral protection ( $I_r, I_{sd}$ ) x ...	OFF - 50% - 100%
instantaneous neutral protection $I_i$	Same as phases
time delay	Same as $t_r, t_{sd}$ and instantaneous

2.1.4  
Energy trip units

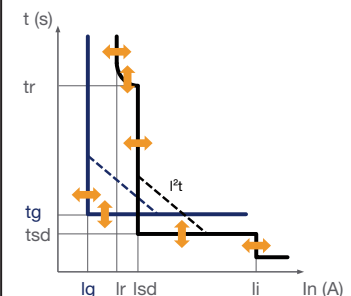

Configuration using adjustment dial, joystick and embedded display.

- Signalling the status of the trip unit via LED (Ready).
- Signalling the PTA overload pre-alarm via LED (adjustable threshold)
- Signalling the overload alarm via LED ( $>I_r$ ).
- Possible adjustment of the thresholds and time delays of the LSIG protection.
- Possible adjustment of the neutral pole protection on 4-pole versions (neutral positioned on the left).

**Protection function**

**L - Long time delay protection**

**S - Short time delay protection**

**I - Instantaneous protection**

**G - Ground protection**

Setting all the protection parameters. See § 3.2 Protection function.

**Measurement function**

See § 3.3 Measurement function

**Alarm management**

Pre-alarms



Trip alarms  
 Customisable alarms  
 System alarms  
 See § 3.4 Managing alarms and logs

**Event logs**

Trips,  
 Alarms  
 Settings  
 See § 3.4 Managing alarms and logs

**Integrated outputs**

PTA output contact  
 OAC output contact

**Other configurations**

Refer to § 3.3.10 Configuring measurements, page 55.

The Energy trip unit can be supplied via an external supply in order to ensure continuous operation of the measurement, alarm and configuration functions. However, these functions can also continue without an external supply, from the following minimum conditions:

- Circuit breaker closed
- minimum current through the circuit breaker; below is a table per rating









<b>Rating</b>	<b>1 pole supplied</b>	<b>2 poles supplied</b>	<b>3 poles supplied</b>
40 A	NA	>14 A	>10 A
100 A	>25 A	>15 A	>15 A
160 A	>32 A	>16 A	>16 A
250 A	>50 A	>25 A	>25 A

It is recommended to use the HTG911H 24 VDC SELV (Safety Extra Low Voltage) supply as an external supply.

In addition, it is recommended to use a secure 24 VDC supply to guarantee complete continuity of service and correct operation even if the event of a distribution network failure.

2.1.5  
Meaning of LEDs and alarm  
notifications

LED indicators on the front face and pop-ups on the embedded display indicate changes in the operating status and alarm status of the LSnl, LSI, LSIg and Energy circuit breakers.

	LSnl	LSI LSIG	Energy	
OAC output alarm	-	-	Notification  OAC	OAC output contact activated
Trip alarm	-	-	Notification  LTD 299A PH.1	Indicates the type of trip and its cause: - LTD: Long time delay - STD: Short time delay - INST: Instantaneous - GROUND: Ground fault protection - TEST: Test mode using MIP
Trip unit temperature alarm	-		Notification 	Permanent red LED or notification on Energy: Internal trip unit temperature > 105 °C
Overload alarm	-		-	- <b>flashing red:</b> I ≥ 105% Ir - <b>permanent red:</b> I ≥ 112% Ir
PTA overload pre-alarm			-	LED 90% Ir or PTA - <b>flashing orange:</b> Threshold 90% Ir or PTA threshold reached - <b>permanent orange:</b> PTA contact activated
Trip unit status	-		-	- <b>permanent green:</b> The trip unit is operational - <b>flashing orange:</b> Internal trip unit fault. MCCB is defective and can no longer ensure the protection of the electrical installation

The range of h3+ moulded case circuit breakers with electronic trip units are available with a communicating variant - the Energy circuit breaker accompanied by its communication system.

The h3+ communication system is composed of the following communication accessories and their connection to the Energy circuit breaker:

- HTP610H configuration tool
- HTD210H panel display
- Modbus communication module
- AX/AL Energy auxiliary.

In addition to its communication system, the h3+ Energy circuit breaker meets the latest energy efficiency standards thanks to its ability to measure energy levels and to it having a wide range of measurement variables such as voltage, current, power, frequency, etc.

The h3+ communication system is used to configure the Energy circuit breaker and to view its measurement and status data, whether at a local level or a more extensive monitoring level in the building in which this system is installed.

At a local level, the Energy circuit breaker data is configured and displayed using an embedded display or optionally using a panel display.

At an extensive level, the Energy circuit breaker can be connected to an optional module in order to send its data to a monitoring system via a Modbus RTU communication bus.

It is particularly suited to the Hager agardio.manager data server.



h3+ communication system

It is recommended to use the HTG911H 24 VDC supply to render this system functional.

**2.3.1**  
**Field of application**

The h3+ configuration tool is particularly recommended for configuration, testing, commissioning and diagnostic operations on h3+ circuit breakers with electronic trip units (LSnI, LSI, LSIg, Energy).



HTP610H configuration tool

It enables users to do the following:

- View the status of the Energy circuit breaker and its identification parameters
- Synchronise the date and time of the Energy circuit breaker
- Set all the parameters of the Energy circuit breaker
- Activate/deactivate data write permission in order to prevent any remote modifications
- Display the electrical variable measurements in real-time and variables calculated.
- Perform the LSnI, LSI, LSIg and Energy trip unit test
- Test the activation of the Energy circuit breaker output contacts
- Manage the predefined alarms and customisable alarms
- View the event logs (trips, operations, alarms, settings)
- Manage user accounts
- Update the configuration software and re-generate passwords for communicating accessories.

**2.3.2**  
**Energy trip unit test**

The HTP610H configuration tool is used to test and check the operation of the LSnI, LSI, LSIg and Energy circuit breakers. The test involves checking that the electronic and mechanical chain of the trip unit trips correctly after simulating overload currents and short circuits.

This test can be configured as follows:

- Individual or total on phase pole, neutral pole or ground fault protection
- Automatic, semi-automatic or manual test
- Inclusion (or not) of the overload pre-alarm threshold and the overload alarm threshold

This test function is also used to display the trip curve.

**2.3.3**  
**Accessing the h3+ configuration WEB pages**

The HTP610H h3+ configuration tool is composed of a portable configuration unit, an MIP adapter lead, a connection cable and a 110 - 230 VAC charger adapter. The assembly is supplied in a carry case.

The unit is equipped with a rechargeable battery and is connected to the Energy circuit breaker on the front face by the MIP connector.



Configuration unit

The portable configuration unit embeds the h3+ configuration Web server enabling the user to connect to it without having to install or download a software application. The h3+ configuration server navigation pages can be accessed from the web browser of a Smartphone, multimedia tablet or laptop.

There are two possible types of connection between the device and the server:

- Wireless Wi-Fi connection
- Wire connection via Ethernet cable

**2.4.1  
Presentation**

The HTD210H panel display is an optional accessory which is used to configure the Energy trip unit and display the data on a panel or door near the circuit breaker.



HTD210H panel display

It is easily mounted on a door or a panel of a board thanks to its minimal depth behind the door.  
Only an accessories cable is necessary to provide the connection with the Energy circuit breaker (24 VDC supply included).  
The front of the equipment is protected by a transparent and sealed wall in order to obtain IP65 protection once installed in an appropriate distribution board.  
The LCD screen is backlit to ensure it can be easily read even at low ambient light.

**2.4.2  
Characteristics of the  
HTD210H display**

**Functions of the HTD210H panel display**

The HTD210H display provides the following information:

- The circuit breaker protection parameters
- The variables measured by the circuit breaker
- The alarm management parameters
- The event logs
- The identification characteristics of the circuit breaker

It is used to define and modify the following data:

- Circuit breaker protection parameters
- Measurement parameters
- Output contact parameters
- Alarm management

**Technical specifications**

<b>Dimensions</b>	97 x 97 x 46 mm (27 mm behind the door)
<b>Door cutout</b>	92 x 92 mm
<b>Screen dimensions</b>	37 x 78 mm
<b>Display</b>	blue backlight
<b>Alarm LED</b>	flashing red
<b>Communication LED</b>	flashing yellow
<b>Power supply LED</b>	permanent green
<b>Typical consumption</b>	2 VA
<b>Operating temperature</b>	-10 °C...+55 °C
<b>Category of use</b>	III
<b>Protection index</b>	IP65 (rear IP20)
<b>Rated operating voltage</b>	24 VDC (+/- 30%)

The communication module for the HTC3x0H series enables all the data saved by the h3+ Energy circuit breaker to be shared with a compatible Modbus RTU monitoring system. It is particularly recommended to be interfaced with the HTG411H agardio.manager data server.



Modbus communication connection

The Modbus parameters can be adjusted on the front face using the adjustment dials:

- Modbus address from 1 to 99
- Parity
- BAUD rate

The Modbus communication module has a 120 Ω terminating resistor. This resistor can be activated/deactivated via a switch on the front panel. There are two versions with or without input and output contacts.

- **HTC310H:** Without input and output contacts
- **HTC320H:** With 2 input contacts and 2 output contacts

**Technical specifications**

<b>Width</b>	2 modules
<b>Input contacts</b>	type 24 VDC (15 – 30 VDC), 2 mA - 15 mA
<b>Output contacts</b>	≤ 100 VDC (type 24, 48 VDC),
<b>Consumption</b>	40 mA / 24 VDC
<b>Module supply voltage</b>	24 VDC (+/- 30%)

The AX/AL Energy auxiliary is devoted to the h3+ Energy circuit breaker. It enables the Energy trip unit to count the number of operation cycles, the number of trips related to an electromechanical fault and to specify the status (open/closed/tripped) of the circuit breaker contacts.  
It is connected to the Energy trip unit by means of the ACP connector.



HXS120H AX/AL Energy auxiliary

There are three versions available as an option:

- HXS120H: AX/AL Energy cycle counter
- HXS121H: AX/AL Energy 230 VAC auxiliary contact
- HXS122H: AX/AL Energy 30 VDC auxiliary contact

The references HXS121H and HXS122H contain a free potential AX contact and an AL contact. These references are provided with the pre-wired contacts.



# Function of the Energy trip unit

## Page

---

<b>3.1 Energy trip unit navigation and settings</b>	<b>26</b>
<b>3.1.1</b> Protection menu	26
<b>3.1.2</b> Measurements menu	27
<b>3.1.3</b> Configuration menu	28
<b>3.1.4</b> Information menu	29
<b>3.1.5</b> Live mode	29
<b>3.1.6</b> Navigation principles	30
<b>3.1.7</b> Lock/unlock button	30

---

<b>3.2 Protection function</b>	<b>31</b>
<b>3.2.1</b> Long time delay protection	32
<b>3.2.2</b> Short time delay protection	34
<b>3.2.3</b> Instantaneous protection	36
<b>3.2.4</b> Ground protection	37
<b>3.2.5</b> Neutral protection	38
<b>3.2.6</b> Selectivity per zone function (ZSI)	39

---

<b>3.3 Measurement function</b>	<b>41</b>
<b>3.3.1</b> Overview of measurements	41
<b>3.3.2</b> Measurements in real-time	42
<b>3.3.3</b> Min/max measurements	44
<b>3.3.4</b> Measuring unbalances	46
<b>3.3.5</b> Power measurements	47
<b>3.3.6</b> Energy measurements	49
<b>3.3.7</b> Measuring values averaged over an interval	49
<b>3.3.8</b> Measuring total harmonic distortion (THD)	52
<b>3.3.9</b> Measuring power factors	53
<b>3.3.10</b> Configuring measurements	55
<b>3.3.11</b> Accuracy of measurements	58

---

<b>3.4 Managing alarms and logs</b>	<b>60</b>
<b>3.4.1</b> Principle of Energy trip unit alarms	60
<b>3.4.2</b> PTA overload pre-alarm	61
<b>3.4.3</b> Trip alarms	62
<b>3.4.4</b> Customisable alarms	63
<b>3.4.5</b> System alarms	66
<b>3.4.6</b> Configuring alarms	67
<b>3.4.7</b> Alarm log	70

---

The front face of the Energy electronic trip unit groups together the following elements:

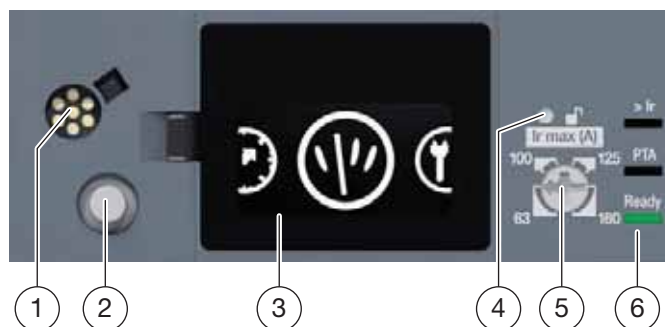

Key	
①	MIP connector
②	h3+ joystick
③	Embedded display
④	Unlock button
⑤	Ir max adjustment dial
⑥	Indicator LEDs

The embedded display enables the settings of the Energy trip unit to be accessed and the measurements and statuses to be viewed by means of the following 4 main menus:

Protection	Measurements	Configuration	Information

### 3.1.1 Protection menu



The Protection menu is composed of sub-menus in order to display and modify each protection setting for the trip unit:

	Threshold setting	Time setting	Other setting
Long time delay protection			
Short time delay protection			
Instantaneous protection			
Ground fault protection			
Neutral protection			

3.1.2  
Measurements menu



Voltages on panel display

The Measurements menu is composed of views enabling some of the measurements taken by the trip unit to be displayed:

Variable measured	Symbol	Unit	Display resolution
Instantaneous current per phase and neutral	I1, I2, I3, IN	A	1 A
Maximum instantaneous current per phase and neutral	I1 max, I2 max, I3 max, IN max	A	1 A
Ground fault instantaneous RMS current	IG	A	1 A
Phase/neutral RMS voltage	V1N, V2N, V3N	V	1 V
Maximum phase/neutral RMS voltage	V1N max, V2N max, V3N max	V	1 V
Phase/phase RMS voltage	U12, U23, U31	V	1 V
Maximum phase/phase RMS voltage	U12 max, U23 max, U31 max	V	1 V
Active power per phase	P1, P2, P3	kW	1 kW
Maximum active power per phase	P1 max, P2 max, P3 max	kW	1 kW
Total active power	Ptot	kW	1 kW
Reactive power per phase	Q1, Q2, Q3	kvar	1 kvar
Maximum reactive power per phase	Q1 max, Q2 max, Q3 max	kvar	1 kvar
Total reactive power	Qtot	kvar	1 kvar
Active and reactive energy	Ea, Er	kWh, kvar	adaptive
Phase sequence	$\phi$ SEQ	-	-
Cos phi total (absolute value)	cos $\phi$	-	0.01
Frequency	-	Hz	0.1 Hz

### 3.1.3 Configuration menu



The Configuration menu is composed of sub-menus used to display and modify the following trip unit parameters:

- Time and date
- Orientation of the display
- Brightness
- Standby mode.
- Reset maximum measurement values.
- Return to factory settings.
- Data write permission



#### Setting the time sub-menu

The time of the trip unit can be set using this menu. The time can also be set using the HTD210H panel display, the h3+ configuration tool, or even via a time synchronisation order from the Modbus master.



#### Setting the date sub-menu

The date of the trip unit can be set using this menu. The date can also be set using the HTD210H panel display, the h3+ configuration tool, or even via a time synchronisation order from the Modbus master.



#### Setting the display orientation sub-menu

It is possible to rotate the screen display in 4 directions: Upwards, downwards, to the left or to the right.

The display is optimised to ensure maximum readability regardless of the orientation.



Orientation to the right



#### Adjusting the brightness sub-menu

The brightness can be set to 20%, 40%, 60%, 80% or 100% (60% by default).



#### Standby mode sub-menu

When Standby mode is activated, the display switches off after 5 minutes if the joystick is not moved. Standby mode is activated by default and can be activated.

If the joystick is moved within 15 minutes of the display being put on standby, the last display before standby will be shown. Otherwise, the display will be set to a view of the Main menu.

Standby mode is deactivated by one of the following events:

- Action on the joystick
- Alarm pop-up.



#### **Reset maximum measurement values sub-menu**

This sub-menu is used to reset the maximum stored current, voltage and power values. This reset command not only changes these maximum values, but it also resets the energy counters.



#### **Return to factory configurations sub-menu**

This sub-menu is used to reset the settings accessible from the embedded display to its initial delivery configurations.



#### **Data write permission sub-menu**

This sub-menu is used to activate/deactivate data write permission for the Energy trip unit in order to avoid any remote modifications. By default, data write permission is activated (set to ON).

### **3.1.4**

#### **Information menu**



The Information menu is used to display the following information:

- Information about the last electromechanical fault trip
- AX: Number of opening/closing cycles
- AL: Number of trips related to an electromechanical fault

#### **Note**

The information about the number of operating cycles or number of trips can only be used if the AX/AL Energy auxiliary accessory has been installed in the Energy circuit breaker.

### **3.1.5**

#### **Live mode**

Live mode enables the views of the Measurements menu to be continuously displayed at the rate of one view every 3 seconds. To display these views in Live mode, they must have been selected as favourites beforehand from the Measurements menu views available.

Live mode starts automatically after 30 seconds of joystick inactivity and when at least one view is selected as a favourite. By default, no view is selected as a favourite and consequently the display does not switch to Live mode after 30 seconds of inactivity.

#### **Note**

When Live mode short-circuits and no favourites or only one favourite has been selected, the display switches off after 5 minutes of joystick inactivity even if Standby mode has been deactivated.

3.1.6  
Navigation principles

The joystick on the left of the screen is used to navigate through the menus and confirm an action.

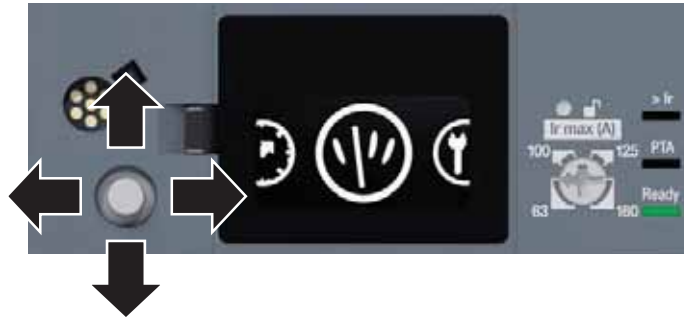

← →	Navigation between the main menus:
↑ ↓	Navigation within a sub-menu
○	<b>Central button</b> Confirmation of an action

3.1.7  
Lock/unlock button

By default, the protection settings for the Energy trip unit are prevented from being modified by locking the navigation function of the embedded display. Navigation is still possible in order to view the data.

Locking prevents any inadvertent modification of the trip unit settings by unauthorised personnel, which would affect the protection level of the trip unit, the measurements taken and its remote communication capabilities:

- Reset measurement statistics
- Return to the factory settings of the embedded display
- Modification of the data write locking parameter.

If there is an attempt to modify a locked parameter using the joystick, a padlock is displayed on the screen to indicate that the locking function is active.



Embedded display locked

To unlock access in order to be able to modify the settings, it is necessary to open the transparent flap and access the unlock button or the Ir max adjustment selector. There are two ways to unlock access:

- By using the Ir max adjustment dial
- By pressing the unlock button.

The Energy electronic trip unit provides protection against overcurrents and insulation faults for all types of electrical power distribution. Its protection characteristics comply with the requirements of standard IEC 60947-2.

**List of protection functions**

- Long time delay protection - **L**: Protection against overloads
- Short time delay protection - **S**: Protection against low current short circuits
- Instantaneous protection - **I**: Protection against high current short circuits
- Ground protection - **G**: Protection against ground insulation faults.

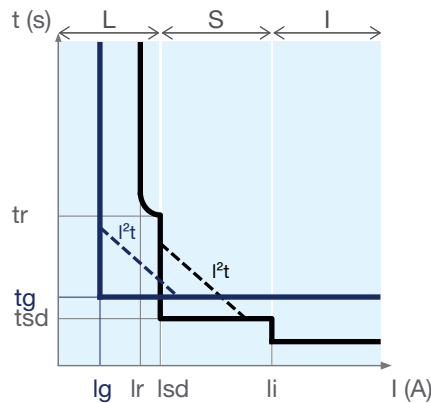

<b>L</b>	I <sub>r</sub>	Long time delay protection threshold
	t <sub>r</sub>	Long time delay
<b>S</b>	I <sub>sd</sub>	Short time delay protection threshold
	t <sub>sd</sub>	Short time delay
	I <sup>2</sup> t ON/OFF	Curve I <sup>2</sup> t on short time delay protection activated or not
<b>I</b>	I <sub>i</sub>	Instantaneous protection threshold
<b>G</b>	I <sub>g</sub>	Ground protection threshold
	t <sub>g</sub>	Ground protection time delay
	I <sup>2</sup> t ON/OFF	Curve I <sup>2</sup> t on ground protection activated or not

**Protection setting means**

The parameters for setting the protection can be modified:

- From the Energy trip unit using the adjustment dial and the integrated screen
- from the HTD210H panel display
- from the HTP610H h3+ configuration tool

All protection functions are based on the root-mean-square value (RMS) of the current to prevent the presence of current harmonics.

The extensive choice of protection curve settings enable selectivity to be coordinated.

**3.2.1 Long time delay protection**

Long time delay protection is designed to protect against current overloads on conductors and receivers in all electrical power distribution applications. The long time delay protection has an inverse time protection function including a thermal imaging function.

**Long time delay protection settings**

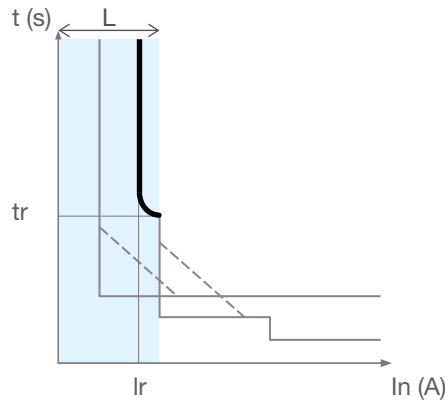

Long time delay protection

**Long time delay parameters**

<b>L</b>	$I_r$	Long time delay protection threshold
	$t_r$	Long time delay

**$I_r$  threshold setting**

The long time delay protection trip range is: 1.05...1.20  $I_r$  according to standard IEC 60947-2.

The trip threshold tolerance  $I_r$  for the long time delay protection is +5% to +20%. The  $I_r$  threshold is firstly set using the  $I_r$  max adjustment dial, then, if necessary, from the embedded display to facilitate fine adjustments in increments of 1 A.

Rating ( $I_n$ )	$I_r$ max threshold setting range (A) / $I_r$ threshold fine adjustment range (A)				
<b>40 A</b>	<b><math>I_r</math> max 16</b>	<b><math>I_r</math> max 25</b>	<b><math>I_r</math> max 32</b>	<b><math>I_r</math> max 40</b>	-
	16 - 16	16 - 25	16 - 32	16 - 40	-
<b>100 A</b>	<b><math>I_r</math> max 40</b>	<b><math>I_r</math> max 63</b>	<b><math>I_r</math> max 80</b>	<b><math>I_r</math> max 100</b>	-
	40 - 40	40 - 63	40 - 80	40 - 100	-
<b>160 A</b>	<b><math>I_r</math> max 63</b>	<b><math>I_r</math> max 80</b>	<b><math>I_r</math> max 100</b>	<b><math>I_r</math> max 125</b>	<b><math>I_r</math> max 160</b>
	63 - 63	63 - 80	63 - 100	63 - 125	63 - 160
<b>250 A</b>	<b><math>I_r</math> max 100</b>	<b><math>I_r</math> max 125</b>	<b><math>I_r</math> max 160</b>	<b><math>I_r</math> max 200</b>	<b><math>I_r</math> max 250</b>
	100 - 100	100 - 125	100 - 160	100 - 200	100 - 250

**Adjusting the  $t_r$  time delay**

The  $t_r$  time delay defines the trip time of the long time delay protection for a current of  $6 \times I_r$ .

The  $t_r$  time delay can be adjusted from the embedded display, the panel display or the h3+ configuration tool.



**tr adjustment range (s)**

0.5	1.5	2.5	5	7.5	9	10	12	14	16
-----	-----	-----	---	-----	---	----	----	----	----

The trip time tolerance for long time delay protection is -20% + 20ms to 0% + 30 ms.

Example:

For  $t_r = 5\text{ s}$  and  $I = 6 \times I_r$ , the trip time for long time delay protection will be between 3.98s and 5.03s.

**Modelling conductor heating by thermal imaging**

LSnI, LSI, LSiG and Energy electronic trip units have a thermal imaging function. This function models the heating and cooling of the electrical conductors. It enables the Energy circuit breaker to protect the conductors against current overloads by taking into account the thermal state of these conductors.

In the presence of current, the h3+ electronic trip units model the heating of the conductors. In the absence of current, the h3+ electronic trip units model the cooling of the conductors.

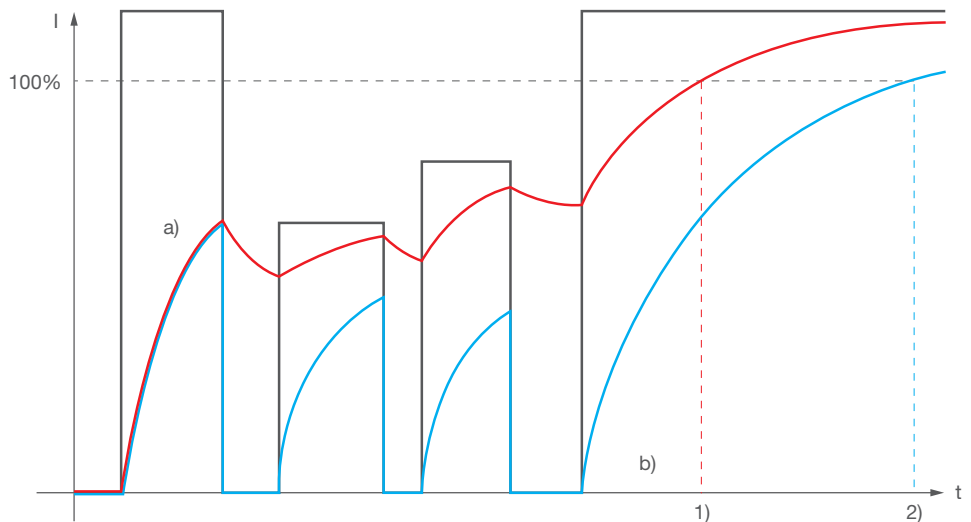

Trip units with and without cooling

**Trip units with and without consideration of conductor cooling**

Key:

- a) Trip unit with consideration of cooling
- b) Trip unit without consideration of cooling
- 1) Tripping of trip unit type a)
- 2) Tripping of trip unit type b).

The example above clearly shows how trip unit a) trips earlier than trip unit b) therefore providing optimum protection to the conductors.

h3+ electronic trip units are type a) trip units.

In addition, they take into account the cooling of the conductors not only before, but also after tripping.

The cooling phase lasts between 1 and 35 minutes depending on the  $t_r$  time delay setting.

**Note**

The thermal imaging function of the h3+ electronic trip units cannot be deactivated.

**3.2.2**  
**Short time delay protection**

The short time delay protection is designed to protect against short circuits.

**Short time delay curve**

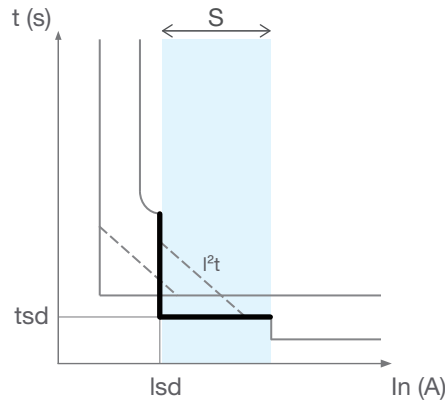

Short time delay protection

**Short time delay parameters**

<b>s</b>	$I_{sd} \times I_r$	Short time delay protection threshold
	$t_{sd}$ (ms)	Short time delay
	$I^2t$ (ON/OFF)	Inverse time $I^2t$ function

**$I_{sd}$  threshold setting**

The  $I_{sd}$  trip threshold can be adjusted from the embedded display, the panel display or the h3+ configuration tool.

<b><math>I_{sd}</math> threshold adjustment range (x <math>I_r</math>)</b>	<b>Adjustment step</b>
OFF - 1.5 to 10	0.5

When the  $I_{sd}$  threshold is OFF, the short time delay protection is deactivated. The  $I_{sd}$  trip threshold tolerance for short time delay protection is  $\pm 10\%$ .

**Adjusting the  $t_{sd}$  time delay**

The  $t_{sd}$  time delay can be adjusted from the embedded display, the panel display or the h3+ configuration tool.

<b><math>I_{sd}</math> threshold adjustment range (x <math>I_r</math>)</b>				
50	100	200	300	400

The trip time tolerance for short time delay protection is:

- For  $t_{sd} = 50$  ms: -30 ms / +30 ms
- For  $t_{sd} \geq 100$  ms: -20 ms / +50 ms

An inverse time function  $I^2t = K$  can be activated or deactivated when adjusting the short time delay.

This  $i^2t$  function makes it possible to improve selectivity with downstream devices. It is activated from the  $I_{sd}$  threshold and works up to  $10 \times I_r$ .

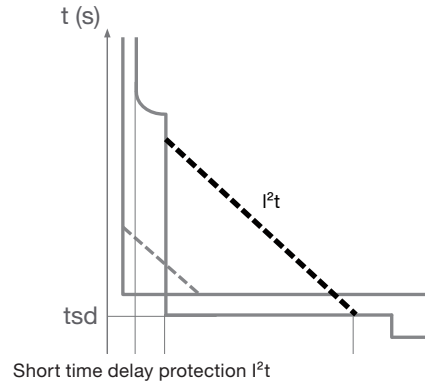

**3.2.3**  
**Instantaneous protection**

The instantaneous protection is designed to protect against high strength short circuits. It is independent time protection.

**Instantaneous protection curve**

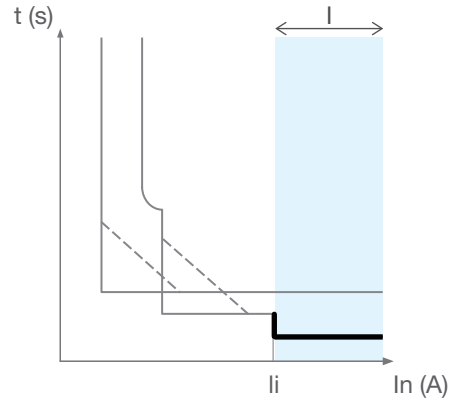

Instantaneous protection

**Instantaneous parameters**

<b>s</b>	<b><math>I_i</math> (x <math>I_n</math>)</b>	<b>Instantaneous protection threshold</b>
----------	--	---

**Adjusting the  $I_i$  threshold**

The  $I_i$  trip threshold can be adjusted from the embedded display, the panel display or the h3+ configuration tool.

Rating ( $I_n$ )	Max Ir selector adjustment values (A)	Adjustment step (x $I_n$ )
40 A	3 to 15	0.5
100 A		
160 A	3 to 11	
250 A		

The  $I_i$  trip threshold tolerance for instantaneous protection is  $\pm 15\%$ .

**Trip time**

The instantaneous protection has no adjustable time delay.  
The non-trip time is 10 ms.  
The maximum cut-out time is 50 ms.

**3.2.4**  
**Ground protection**

Ground protection is protection against high strength insulation faults present in installations with a TN-S earthing system.

It is independent time protection.

**Ground protection curve**

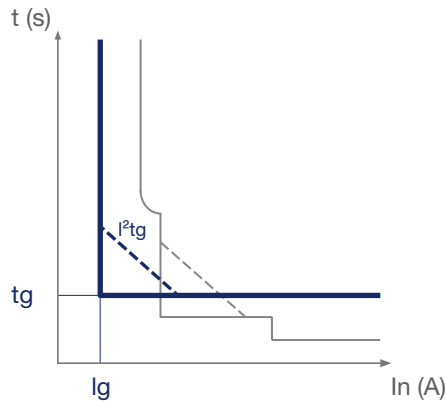

Ground protection

**Ground parameters**

<b>G</b>	$I_g$ (xIn)	Ground protection threshold
	$t_g$ (ms)	Ground time delay
	$i^2 t_g$ (ON / OFF)	Inverse time $i^2 t$ function

**Adjusting the  $I_g$  threshold**

The  $I_g$  trip threshold can be adjusted from the embedded display, the panel display or the h3+ configuration tool.

Rating (In)	$I_g$ threshold adjustment ranges (xIn)	Adjustment step (xIn)
<b>40 A</b>	OFF - 0.4 to 1	0.05
<b>100 A</b>	OFF - 0.2 to 1	
<b>160 A</b>		
<b>250 A</b>		

The  $I_g$  trip threshold tolerance for ground protection is  $\pm 10\%$ .

When the  $I_g$  threshold is OFF, ground protection is deactivated.

**$t_g$  time delay**

The  $t_g$  time delay can be adjusted from the embedded display, the panel display or the h3+ configuration tool.

**$t_g$  time delay adjustment range (ms)**

50	100	200	300	400	500
----	-----	-----	-----	-----	-----

The trip time tolerance for ground protection is:

- For  $t_g = 50$  ms: -30 ms / +30 ms
- For  $t_g \geq 100$  ms: -20 ms / +50 ms

Ground protection is a protection against high strength insulation faults. It is similar to short time delay protection. It also has an inverse time  $I^2t$  function, which can be activated or deactivated when adjusting this protection.

This  $i^2t$  function makes it possible to improve selectivity of ground faults with downstream devices. It is activated from the  $I_g$  threshold and functions up to  $I_n$ .

**3.2.5  
Neutral protection**

Neutral protection is available on Energy 4P circuit breakers. It is particularly useful when the cross-section of the neutral conductor is reduced in relation to the phase conductors.

It uses the long time delay, short time delay and instantaneous protection parameters.

**Neutral protection curve**

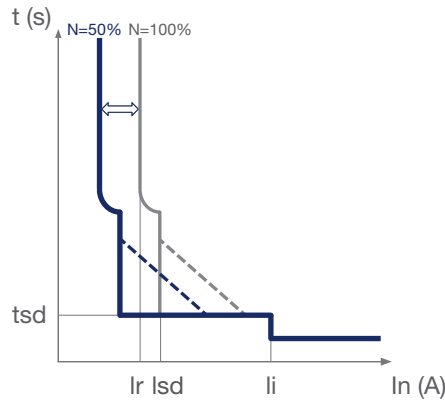

Neutral protection

**Adjusting the Ir and Isd thresholds for neutral protection**

N coefficient adjustment range (%)	Parameters impacted
OFF - 50 - 100	The coefficient is applied to the adjustment value of the Ir and Isd thresholds for the phases.
The instantaneous current threshold remains identical to that of the phases.	

The N coefficient can be adjusted from the embedded display, the panel display or the h3+ configuration tool.

**Neutral protection time delay**

The time delays for neutral protection remain identical to the phase time delay adjustment values.

**3.2.6**  
**Zone Selective Interlocking**  
**function (ZSI)**

The Zone Selective Interlocking function is designed to reduce electrodynamic stress in the electrical power distribution system (conductors and busbars) when time selectivity is activated.

It applies to the upstream section of the electrical power distribution system composed mainly of open circuit breakers and moulded case type circuit breakers. It involves connecting the upstream and downstream circuit breakers with a special cable. This connection may or may not inhibit the  $t_{sd}$  and/or  $t_g$  time delay of the circuit breakers depending on the location of the short-circuit fault.

When the Zone Selective Interlocking function is activated on a circuit breaker, it inhibits its time delay settings and has an almost instantaneous trip time. When it is not activated, the circuit breaker operates according to the trip time delay settings.

The Zone Selective Interlocking function is supplementary to time selectivity ( $t_{sd}$  and  $t_g$  time delay). Under no circumstances can it replace it.

It is applicable to short time delay protection and ground protection.

Here are two examples to explain the functioning.

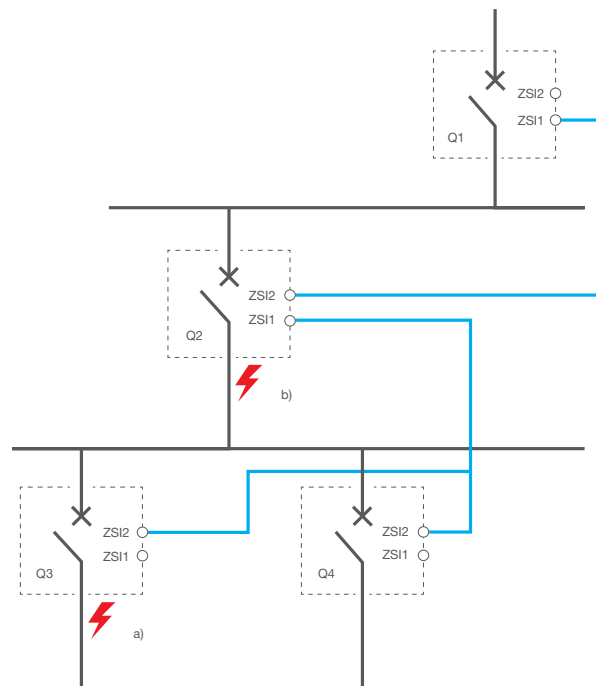

Zone Selective Interlocking: Example

First, circuit breakers Q1, Q2, Q3, Q4 are set to their respective thresholds enabling time selectivity to be activated.

Fault example a):

- **In the event of a fault downstream of circuit breaker Q3**, circuit breakers Q1, Q2 and Q3 detect the fault at the same time. Thanks to the connection cable between the circuit breakers, circuit breaker Q3 informs circuit breaker Q2 that it has detected the fault. Circuit breaker Q2 then informs circuit breaker Q1 that it has also detected the fault. Circuit breakers Q1 and Q2 then maintain their respective time delays so that circuit breaker Q3 can eliminate the fault instantly.

Fault example b):

- **In the event of a fault downstream of circuit breaker Q2**, only circuit breakers Q1 and Q2 detect the fault. Thanks to the connection cable between the circuit breakers, circuit breaker Q2 informs circuit breaker Q1 that it has detected the fault. Circuit breaker Q1 then maintains its time delays whilst circuit breaker Q2 inhibits its time delays to eliminate the fault instantly.

#### Setting the ZSI protection

The Energy P160 circuit breaker does not require any ZSI protection to be configured. It is equipped with a ZSI output (ZSI2) to connect an upstream circuit breaker. It is mainly designed to protect the feed circuit and does not allow receipt of a ZSI signal from a downstream circuit breaker to be acknowledged.

The Energy P250 circuit breaker must activate the ZSI protection to acknowledge selectivity per zone.

#### ZSI protection settings on P250

##### P250: ZSI setting

Short time delay protection ZSI	ON-OFF (OFF by default)
Ground protection ZSI	ON-OFF (OFF by default)

#### Note

It is important to ensure that ZSI protection on a P250 circuit breaker is kept deactivated when not using the zone selective interlocking function. In fact, in this case, setting the ZSI protection to ON will systematically reduce the trip time to an almost instantaneous time ranging from between 20 and 80 ms.



### 3.3.1 Overview of measurements

The Energy trip unit is used to measure the following types of variables:

		Embedded display	Panel display	Modbus	HTP610H tool
<b>Measurements in real-time</b>					
<b>Currents</b>					
Phase and neutral	I1, I2, I3; IN	X	X	X	X
Arithmetic mean	$I_{avg} = (I1 + I2 + I3) / 3$	-	X	X	X
Instantaneous maximum	I <sub>max</sub> of I1, I2, I3, IN	-	X	X	X
Instantaneous minimum	I <sub>min</sub> of I1, I2, I3	-	X	X	X
Ground fault	IG	X	X	X	X
Unbalance per phase	I1 Unba, I2 Unba, I3 Unba; IN Unba	-	-	X	X
Maximum instantaneous unbalance	Max Unba I	-	X	X	X
<b>Voltages</b>					
phase-phase	U12, U23, U31	X	X	X	X
phase-neutral	V1N, V2N, V3N	X	X	X	X
Ph-Ph arithmetic mean	$U_{avg} = (U12 + U21 + U23) / 3$	-	X	X	X
Ph-N arithmetic mean	$V_{avg} = (V1N + V2N + V3N) / 3$	-	X	X	X
Instantaneous maximum	Voltages Ph-Ph and Ph-N	-	X	X	X
Instantaneous minimum	Voltages Ph-Ph and Ph-N	-	-	X	X
Unbalance	% U <sub>avg</sub> and % V <sub>avg</sub>	-	X	X	X
Maximum unbalance	Max Unba U, Max Unba V	-	X	X	X
Phase sequence	1-2-3, 1-3-2	X	X	X	X
<b>Power</b>					
Active	P total per phase	X	X	X	X
Reactive	Q total per phase	X	X	X	X
Apparent	S total per phase	X	X	X	X
<b>Maximum and minimum values since last reset</b>					
Max. current, voltage per phase and power per phase		X	X	X	X
Max. averages over interval and IG		-	X	X	X
Max. unbalanced currents, power factors, THD		-	-	X	X
Minimum corresponding variables		-	-	X	X
<b>Energy</b>					
Active (kWh), reactive (kvarh), apparent (kVAh)	EaIn, ErIn, received, delivered, Es	X (only EaIn and ErIn)	X	X	X
Active (kWh), reactive (kvarh) absolute partial	Ea Abs, Er Abs	-	-	X	X
Active (kWh), reactive (kvarh) signed partial	Ea, Er	-	-	X	X
Total active (kWh),	EaIn received, EaOut delivered	-	-	X	X

		Embedded display	Panel display	Modbus	HTP610H tool
<b>Averages over interval (Demand values)</b>					
Active (kW), reactive (kvar), apparent (kVA) power	P Dmd, Q Dmd, S Dmd Total/per phase	-	X	X	X
Maximum power since last reset.	Max P Dmd, Max Q Dmd, Max S Dmd Total/per phase	-	X	X	X
Current	I1 Dmd, I2 Dmd, I3 Dmd; IN Dmd, Iavg Dmd	-	-	X	X
Maximum current since last reset.	Max I1 Dmd, Max I2 Dmd, Max I3 Dmd; Max IN Dmd	-	-	X	X
Integration interval sliding, fixed or synchronised by Modbus	Adjustable from 5 to 60 minutes in increments of one minute	-	X	X	X
<b>Power factor</b>					
Power factor and cos $\varphi$ (fundamental)	Total	X (only cos $\varphi$ )	X	X	X
Power factor and cos $\varphi$ (fundamental)	per phase	-	X	X	X
<b>Total harmonic distortion</b>					
Voltage THD	THDU (Ph -Ph), THDV (Ph -N)	-	X	X	X
Current THD	THDI per phase	-	X	X	X
<b>Other</b>					
Frequency	f	X	X	X	X
Phase rotation		X	X	X	X
Quadrant		-	X	X	X

**3.3.2 Measurements in real-time**

The Energy trip unit provides the following basic electrical variable measurements in real-time (every second):

- Current for each phase and neutral (on version 4P)
- Ground fault current (resulting from 3 or 4 currents from active conductors)
- Phase/phase and phase/neutral voltages for the tetrapolar model
- Indication of the phase rotation direction
- Network frequency

The trip unit can be configured to use an inverse phase rotation as a phase sequence reference (see § 3.3.10). This configuration is performed from the HTD210H panel display or the HTP610H configuration tool.

Electrical variable	Symbol used	Version 3 P	Version 4 P
Phase or neutral RMS	I1, I2, I3, IN	X (except IN)	X
Ground RMS (three-phase system with neutral)	IG	-	X

Electrical variable	Symbol used	Version 3 P	Version 4 P
Ground RMS (three-phase system without neutral)	IG	X	-
RMS voltage	V1N, V2N, V3N	-	X
RMS voltage	U12, U23, U31	X	X
Phase rotation	1,2,3; 1,3,2	X	X
Frequency	f	X	X

In addition, the Energy trip unit calculates the following associated electrical variables in real-time (every second):

Electrical variable	Variable calculation	Version 3 P	Version 4 P
Average RMS current	$I_{moyen} = \frac{I_1 + I_2 + I_3}{3}$	X	X
Maximum instantaneous RMS current with neutral	$I_{max} = \max(I_1, I_2, I_3, I_N)$	-	X
Maximum instantaneous RMS current without neutral	$I_{max} = \max(I_1, I_2, I_3)$	X	-
Minimum instantaneous RMS current	$I_{min} = \min(I_1, I_2, I_3)$	X	X
Average Ph-N RMS voltage	$V_{moyen} = \frac{V_{1N} + V_{2N} + V_{3N}}{3}$	-	X
Maximum Ph-N RMS voltage	$V_{max} = \max(V_{1N}, V_{2N}, V_{3N})$	-	X
Minimum Ph-N RMS voltage	$V_{min} = \min(V_{1N}, V_{2N}, V_{3N})$	-	X
Average Ph-Ph RMS voltage	$U_{moyen} = \frac{U_{12} + U_{23} + U_{31}}{3}$	X	X
Maximum Ph-Ph RMS voltage	$U_{max} = \max(U_{12}, U_{23}, U_{31})$	X	X
Minimum Ph-Ph RMS voltage	$U_{min} = \min(U_{12}, U_{23}, U_{31})$	X	X

### 3.3.3 Min/max measurements

The Energy trip unit calculates the real-time maximum and minimum values reached since the last reset.  
Certain values are time stamped.

All of these values take into account the positive and negative values.  
For example, if the previous maximum value was 25 and a value of -30 is measured, the new maximum value becomes -30.

Variable monitored		Time stamp	Version 3 P	Version 4 P	
<b>Current</b>					
Maximum	instantaneous	- for I1, I2 and I3	-	X	-
		- for I1, I2, I3 and IN	-	-	X
	since reset	- for each phase	X	X	X
		- for IN	X	-	X
		- for overcurrents	-	X	X
		- for minimum I1, I2 and I3	-	X	X
		- for average current	-	X	X
		- for IG	-	X	X
	- for IN unbalance	-	-	X	
	- for unbalance per phase	-	X	X	
- for maximum unbalances	-	X	X		
Minimum	instantaneous	- for I1, I2 and I3	-	X	X
		- for I1, I2, I3 and IN	-	-	X
	since reset	- for each phase	-	X	X
		- for IN	-	-	X
		- for undercurrents	-	X	X
		- for maximum I1, I2 and I3	-	X	X
		- for average current	-	X	X
		- for IG	-	X	X
	- for IN unbalance	-	-	X	
	- for unbalance per phase	-	X	X	
- for maximum unbalances	-	X	X		
<b>Voltage</b>					
Maximum	instantaneous	- for three Ph-N voltages	-	-	X
		- for three Ph-Ph voltages	-	X	X
	since reset	- for each Ph-N voltage	X	-	X
		- for each Ph-Ph voltage	X	X	X
		- for each Ph-N voltage unbalance	-	-	X
		- for phase-to-neutral unbalance maximums	-	-	X
		- for each Ph-Ph voltage unbalance	-	X	X
		- for line-to-line unbalance minimums	-	X	X
	- for average voltage	-	X	X	
	Minimum	instantaneous	- for three Ph-N voltages	-	-
- for three Ph-Ph voltages			-	X	X

Variable monitored			Time stamp	Version 3 P	Version 4 P
Minimum	since reset	- for each Ph-N voltage	X	-	X
		- for each Ph-Ph voltage	X	X	X
		- for each Ph-N voltage unbalance	-	-	X
		- for phase-to-neutral unbalance maximums	-	-	X
Minimum	since reset	- for each Ph-Ph voltage unbalance	-	X	X
		- for compound unbalance maximums	-	X	X
		- for average voltage	-	X	X

**Frequency**

Maximum	for frequency		X	X	X
Minimum	for frequency		X	X	X

**Power**

Maximum	for total power	- active - reactive - apparent	-	X	X
	for power per phase	- active - reactive - apparent	-	-	X
Minimum	for total power	- active - reactive - apparent	-	X	X
	for power per phase	- active - reactive - apparent	-	-	X
Maximum	for total power factor and cos φ total		-	X	X
Minimum	for total power factor and cos φ total		-	X	X

**Current total harmonic distortion**

Maximum	for current THD	- per phase - maximum instantaneous	-	X	X
Minimum	for current THD	- per phase - maximum instantaneous	-	X	X

**Voltage total harmonic distortion**

Maximum	for THD of Ph-N voltages		-	-	X
	for THD of Ph-Ph voltages		-	X	X
Minimum	for THD of Ph-N voltages		-	-	X
	for THD of Ph-Ph voltages		-	X	X

**Note**

Some or all of these min/max values can be reinitialised using the reset control depending on the interface used:

- Embedded display: Reset the maximum voltages, currents and powers and reset the energy counters.

- HTD210H display: Reset all min/max values and energy counters.
- HTP610H configuration tool: Reset all min/max values and energy counters.

**3.3.4**  
**Measuring unbalances**

The Energy trip unit calculates in real-time (every second) current and voltage unbalances.

Current unbalance is expressed as a % in relation to the average current.

$$I_{avg} = \frac{I1 + I2 + I3}{3}$$

$$I_p \text{ unbalance} = \frac{I_p - I_{avg}}{I_{avg}} \times 100 \quad \text{with } P = 1, 2, 3$$

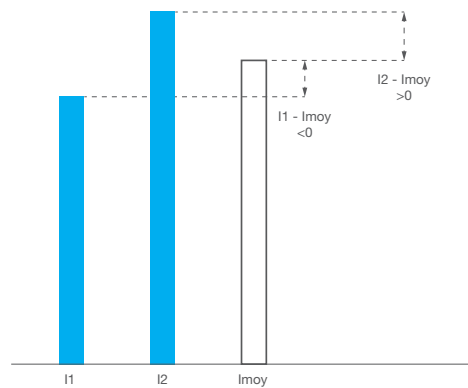

Current unbalance principle

Voltage unbalance is expressed as a % in relation to the arithmetic mean of the corresponding voltage:

$$U_{avg} = \frac{U12 + U23 + U31}{3}$$

$$U_{pg} \text{ unbalance} = \frac{U_{pg} - U_{avg}}{U_{avg}} \times 100 \quad \text{with } pg = 12, 23, 31$$

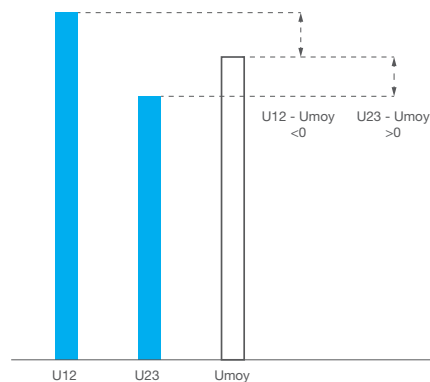

Voltage unbalance principle

List of unbalance values:

Electrical variable	Symbol used	Version 3 P	Version 4 P
Phase current unbalance	I1 Unb, I2 Unb, I3 Unb	X	X
Neutral current unbalance	IN Unb	-	X
Instantaneous maximum phase current unbalance without neutral	Max Unb I	X	-
Instantaneous maximum phase current unbalance with neutral	Max Unb I	-	X
Ph-Ph voltage unbalance	U12 Unb, U23 Unb, U31 Unb	X	X
Ph-Ph maximum instantaneous voltage unbalance	Max Unb U	X	X
Ph-N voltage unbalance	V1N Unb, V2N Unb, V3 Unb	-	X
Ph-N maximum instantaneous voltage unbalance	Max Unb V	-	X

### Note

Unbalance values are indicated in the form of relative values as a %.

Maximum unbalance values are expressed in the form of absolute values as a %.

### 3.3.5 Measuring power

The Energy trip unit calculates the following electrical power in real-time (every second):

- Active power per phase
- Reactive power per phase
- Apparent power per phase
- Total active power
- Total reactive power
- Total apparent power

The exhaustive list of variables calculated, associated with their mathematical definition and their availability according to version 3P or 4P, is given in the following table:

Electrical parameter	Symbol	Definition	Version 3 P	Version 4 P
Active power per phase	P1, P2, P3	$P_p = \frac{1}{N} \cdot \sum_{k=0}^{N-1} (v_{pN_k} \cdot i_{p_k})$	-	X
Apparent power per phase	S1, S2, S3	$S_p = V_{pN} \cdot I_{pA}$	-	X
Reactive power per phase	Q1, Q2, Q3	$Q_p = \text{Signe}(\varphi_p) \cdot \sqrt{S_p^2 - P_p^2}$	-	X
Total active power	Ptot	$P = P_1 + P_2 + P_3$	X	X
Total reactive power	Qtot	Vector or arithmetic addition depending on configuration, see § 3.3.10	X	X
Total apparent power	Stot	Vector or arithmetic addition depending on configuration, see § 3.3.10	X	X

### Details about the calculations

The calculations of these powers take into account the harmonics up to rank 31.

Symbol	Definition
<b>N</b>	Total number of samples per network period
<b>T</b>	Period measured, in seconds
$i_{pk}$	k sample number of phase p current
$v_{pN_k}$	k sample number of voltage between phase p and neutral
$\varphi_p$	Phase difference between the current and the voltage for phase p
$h_i$	Rank i harmonic component

Sampling involves taking samples at regular intervals of the instantaneous values of the current and voltage analogue signals. The digitisation of the electrical variables performed by the Energy trip unit results in a set of discrete values all synchronised in relation to each other. This method also makes it possible to take into account the dephasing between the voltage and the current ( $\cos \varphi$ ).

### Power sign

The power values are signed.

The Energy circuit breaker can be supplied both from the top and from the bottom. It is therefore important to configure the power value sign in line with the supply direction. This configuration is performed from the HTD210H panel display or the HTP610H configuration tool (see § 3.3.10).

The active power is given with the + sign when it is "delivered", i.e. when the equipment is working as a receiver.

The active power is given with the - sign when it is "received", i.e. when the equipment is working as a generator.

The reactive power is given with the same sign as the active energy and power, when the current lags the voltage, i.e. when the equipment is inductive.

The reactive power is given with the opposite sign to the active energy and power, when the current is ahead of the voltage, i.e. when the equipment is capacitive.

The operating quadrant (I, II, III, IV) is therefore given according to the power sign.

	P < 0	P > 0
Q > 0	<b>II</b> Capacitive (advance)	<b>I</b> Inductive (delay)
Q < 0	<b>III</b> Inductive (delay)	<b>IV</b> Capacitive (advance)



**3.3.6**  
**Energy measurements**

The Energy trip unit calculates the various energy levels by integrating the instantaneous power over a network period.

The Energy trip unit supplies several energy counters which can count up to 4,294,967,295 kWh / kvarh / kVAh. All of these counters provide unsigned absolute values except for the signed counters. They count the stored energy by increasing incrementally every second.

The partial energy counters can be reset from the embedded display, the panel display and the HTP610H configuration tool.

Partial energy counter	Symbol	Reset
Active energy delivered	Ea In,	X
Active energy received	Ea Out	X
Reactive energy delivered	Er In	X
Active energy received	Er Out	X
Absolute active energy (delivered + received)	Ea abs	X
Absolute reactive energy (delivered + received)	Er Abs	X
Signed active energy	Ea	X
Signed reactive energy	Er	X
Apparent energy	Es	X

Total energy counter	Electrical variable	Reset
Active energy delivered	Ea In NR	No reset
Active energy received	Ea Out NR	No reset

**Note**

The Erln, ErOut, Er Abs, Er, Es values depend on the arithmetic or vector addition convention for reactive or apparent power (see configuration, see § 3.3.10).

**3.3.7**  
**Demand values (averaged values over an interval)**

The Energy trip unit calculates the averaged current and power values by integration over a given time interval. These are the Demand values or the averaged values over an interval. These values are useful in order to create a load profile for the loads supplied by the Energy circuit breaker. They must not be confused with the instantaneous averages (Instantaneous average current, etc.).

**Calculation principle**

The Energy trip unit calculates a value averaged (Demand value) out over an interval using the electrical measurement G over a time interval T divided by this same interval T.

$$G_{moyen} = \frac{1}{T} \int_0^T G \cdot dt$$

The time interval T designates the configurable integration interval.

There are 3 types of integration interval:

- Fixed integration interval
- Sliding integration interval

- Synchronised integration period (Sync. Bus)

**Fixed integration interval**

The calculation intervals are consecutive.  
A new average value is calculated at the end of the interval.

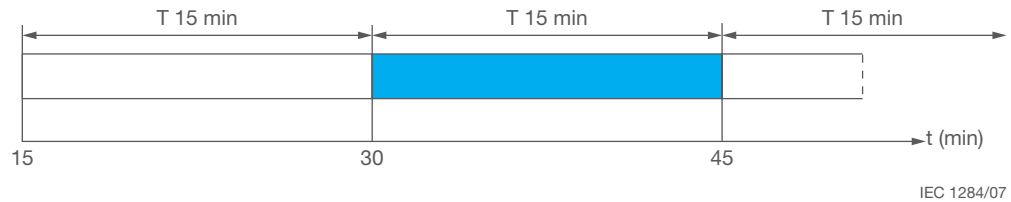

Fixed integration interval

The duration of interval T can be configured between 5 and 60 minutes in increments of 1 minute.

**Sliding integration interval**

The calculation intervals are consecutive.  
A new average value is produced every minute.

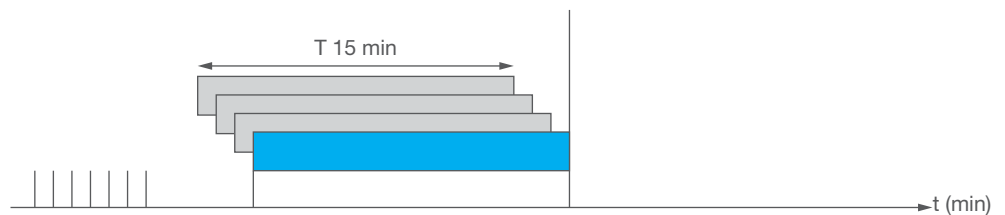

Sliding integration interval

The duration of interval T can be configured between 5 and 60 minutes in increments of 1 minute.

**Synchronised integration interval**

When the first synchronisation pulse is received, a first averaged value calculation is initialised. For each new pulse, the integration in progress is stopped and the average value available is updated. At the same time, a new calculation is initialised.

The time interval between two synchronisation pulses must be between 1 and 60 minutes. If the interval exceeds 60 minutes, integration of the measurement stops and the measurements up to the next synchronisation pulse are not taken into account.

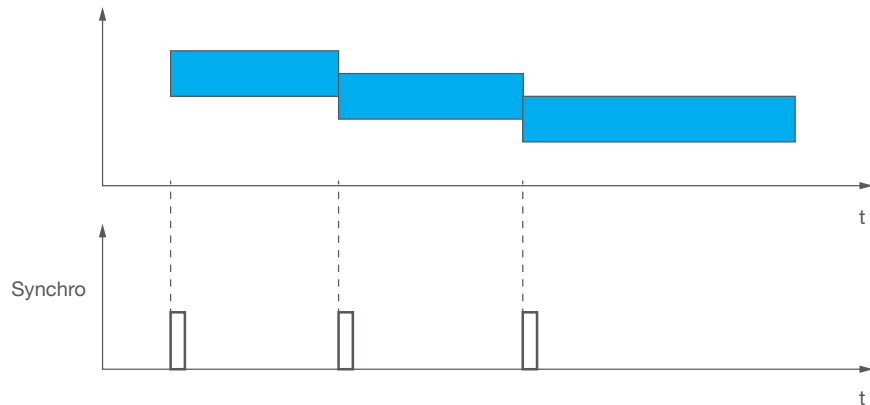

Synchronised integration interval

**Averaged values maximum**

For each averaged value (Demand value) period calculated, the maximum value over the time interval is stored.

The maximum values can be reset via the HTP610H configuration tool or via the HTD210H display.

The exhaustive list of variables calculated according to version 3P or 4P and the display interface are given in the following table:

Electrical variable	Symbol	Version 3P	Version 4P	Panel display	Modbus	HTP610H tool
Phase currents	I1 Dmd, I2 Dmd, I3 Dmd	X	X	-	X	X
Neutral current	IN Dmd	-	X	-	X	X
Average current	Iavg Dmd	X	X	-	X	X
Active power per phase	P1 Dmd, P2 Dmd, P3 Dmd	-	X	X	X	X
Total active power	Ptot Dmd	X	X	X	X	X
Reactive power per phase	Q1 Dmd, Q2 Dmd, Q3 Dmd	-	X	X	X	X
Total reactive power	Qtot Dmd	X	X	X	X	X
Apparent power per phase	S1 Dmd, S2 Dmd, S3 Dmd	-	X	X	X	X
Total apparent power	Stot DSmd	X	X	X	X	X
Maximum phase currents	Max I1 Dmd, Max I2 Dmd, Max I3 Dmd	X	X	-	X	X
Maximum neutral current	Max IN Dmd	-	X	-	X	X
Maximum average current	Max Iavg Dmd	X	X	-	X	X
Maximum active power per phase	Max P1 Dmd, Max P2 Dmd, Max P3 Dmd	-	X	X	X	X
Maximum total active power	Max Ptot Dmd	X	X	X	X	X

Electrical variable	Symbol	Version 3P	Version 4P	Panel display	Modbus	HTP610H tool
Maximum reactive power per phase	Max Q1 Dmd, Max Q2 Dmd, Max Q3 Dmd	–	X	X	X	X
Maximum total reactive power	Max Qtot Dmd	X	X	X	X	X
Maximum apparent power per phase	Max S1 Dmd, Max S2 Dmd, Max S3 Dmd	–	X	X	X	X
Maximum total apparent power	Max Stot DSmd	X	X	X	X	X

The type of integration interval and the length of interval T can be configured on the HTD210H display and the HTP610H configuration tool (see paragraph 3.3.10).

**Note**

The Qtot Dmd, Stot Dmd, Max Q1 Dmd, Max Q2 Dmd, Max Q3 Dmd, Max Qtot Dmd and Max Stot Dmd values depend on the arithmetic or vector addition convention for reactive and apparent power (see §3.3.10 – Setting the reactive and apparent power calculation convention).

**3.3.8 Measuring total harmonic distortion (THD)**

The Energy trip unit calculates the total harmonic distortion levels from the real-time current and voltage measurements (every second).

These calculations are performed up to rank 31 harmonics.

The total harmonic distortion levels are energy distribution quality indicators. The THDi is used to determine the current wave deformation level. The THDU or THDV is used to determine the voltage wave deformation level.

**Total harmonic distortion THD of current THDi**

The current THD is the percentage of the root-mean-square value of current harmonics of a rank above one, compared to the root-mean-square value of the harmonic current of rank one.

As the level is calculated in relation to the fundamental, its value can exceed 100%.

$$THD_{Ip} = \frac{\sqrt{I_{p h_2}^2 + \dots + I_{p h_{31}}^2}}{I_{p h_1}}$$

Calculation formula symbol	Definition
$I_{p h_n}$	Rank n root-mean-square harmonic component for the current of pole p

The THDi or, in other words, deformation rate of the current wave is caused by receiver non-linearity, which produces non-sinusoidal current waveforms. Therefore the THDi enables potential polluter receivers in energy distribution to be identified.

A THDi < 10% shows low pollution which is generally acceptable.

A THDi up to 50% indicates risky levels of pollution (risk of overheating, etc.).

A THDi above 50% is a high harmonics level and may result in serious degradation, dangerous overheating and risk of malfunctions if the installation has not been designed correctly.

**Total harmonic distortion of voltage THD, THDU, THDV**

The THD of voltage is the percentage of the root-mean-square value of harmonic voltages of a rank above one, compared to the root-mean-square value of the harmonic voltage of rank one.

Its value can theoretically exceed 100% but, in practice, it does not exceed 25%.

$$THD_{U_{pg}} = \frac{\sqrt{U_{pg\ h_2}^2 + \dots + U_{pg\ h_{31}}^2}}{U_{pg\ h_1}}$$

Calculation formula symbol	Definition
$U_{pg\ h_n}$	Harmonic RMS component of rank n for voltage with $pg = 12, 23, 31$

The THD of voltage is used to assess the impact of the impedance of the line on the quality of the voltage at the level of the pollutant receivers. The higher the impedance of the lines supplying these receivers, the higher the THD of voltage.

The exhaustive list of variables calculated according to version 3P or 4P is given in the following table:

Electrical variable	Symbol	Version 3 P	Version 4 P
Phase current THD	THD I1, THD I2, THD I3	X	X
THD of voltage Ph-N	THD V1N, THD V2N, THD V3N	-	X
THD of voltage Ph-Ph	HD U12, THD U23, THD U31	X	X

**3.3.9 Measuring power factors**

The Energy trip unit calculates in real-time (every second) the power factor (PF<sub>tot</sub>) from the ratio of total active power to total apparent power. It also calculates the power factors per phase from the ratios of total active power per phase to apparent power per phase.

Example: Formula for the power factor per phase.

$$PF_x = P_x / S_x$$

Calculation formula symbol	Definition
$x$	Phase number.

The Energy trip unit also calculates in real-time (every second) the total  $\cos \varphi$  from the ratio of total active power reduced to the harmonics of rank 1 to total apparent power reduced to the harmonics of rank 1. In addition, it calculates the  $\cos \varphi$  per phase.

The power factors and the  $\cos \varphi$  are energy distribution quality indicators. Improving these indicators facilitates the following:

- Decrease the reactive energy consumption which may reduce penalties related to electrical consumption costs
- Reduce the cross-section of the cables
- Reduce line losses
- Reduce the voltage drop
- Increase the power available to the transformer.

The exhaustive list of variables calculated according to version 3P or 4P is given in the following table:

Electrical variable	Symbol	Version 3 P	Version 4 P
Power factor per phase	PF1, PF2, PF3	-	X
Total power factor	PFtot	X	X
Cos $\varphi$ per phase (fundamental power factor)	$\cos \varphi 1$ , $\cos \varphi 2$ , $\cos \varphi 3$	-	X
Total $\cos \varphi$ (fundamental power factor)	$\cos \varphi$ tot	X	X

**Note**

The values PF1, PF2, PF3, PFtot,  $\cos \varphi 1$ ,  $\cos \varphi 2$ ,  $\cos \varphi 3$  and  $\cos \varphi$  tot depend on the arithmetic or vector addition convention for reactive and apparent power (see § 3.3.10 - Setting the reactive and apparent power calculation convention).

**PF power factor and  $\cos \varphi$  sign**

The Energy trip unit is used to configure the sign convention to be applied to the power factor and  $\cos \varphi$  values.

Two options are possible:

- **IEC Convention:** The sign for the power factors and  $\cos \varphi$  follows the active power sign
- **IEEE convention:** The sign for the power factors and  $\cos \varphi$  is modified to indicate whether the electrical system is capacitive (+ sign) or inductive (- sign)

IEC convention

	P < 0	P > 0
Q > 0	<b>2</b> Capacitive (lead or ahead) PF < 0 $\cos \varphi < 0$	<b>1</b> Inductive (lag or delay) PF > 0 $\cos \varphi > 0$
Q < 0	<b>3</b> Inductive (lag or delay) PF < 0 $\cos \varphi < 0$	<b>4</b> Capacitive (lead or ahead) PF > 0 $\cos \varphi > 0$

The IEC convention is indicated when the equipment downstream of the circuit breaker can operate in turn as a receiver and as a generator.

IEEE convention

	P < 0	P > 0
Q > 0	<b>II</b> Capacitive (lead or ahead) PF > 0 cos φ > 0	<b>I</b> Inductive (lag or delay) PF < 0 cos φ < 0
Q < 0	<b>III</b> Inductive (lag or delay) PF < 0 cos φ < 0	<b>IV</b> Capacitive (lead or ahead) PF > 0 cos φ > 0

The IEEE convention is indicated when the equipment downstream of the circuit breaker operates exclusively as a receiver or exclusively as a generator. In this case, the + sign designates the capacitive behaviour and the – sign designates the inductive behaviour.

**Note**

The sign convention for power factors and cos φ is configured from the HTD210H panel display or the HTP610H configuration tool (see §3.3.10 – Configuring measurements).

**3.3.10  
Configuring measurements**

The following configurations are possible from the HTD210H panel display or the HTP610H configuration tool.

**Adjusting the reference phase sequence**

This parameter is used to configure the sequence of phases for the network supplying the Energy circuit breaker. In the case of a network with inverse phase rotation, the reference sequence is: 1, 2, 3.

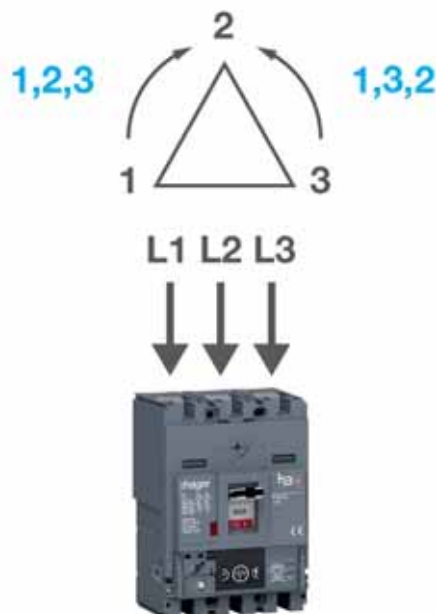

Phase sequence

Phase sequence setting	Default setting
1, 2, 3 – 1, 3, 2	1, 2, 3

**Setting the power sign convention**

The power sign convention parameter is used to configure the power sign according to the supply direction of the Energy circuit breaker.

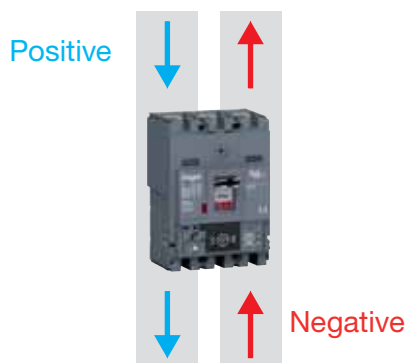

Power sign

P sign convention	Default setting
Positive - negative	Positive

Configuring this convention correctly enables the 4 quadrant set-up to be respected:

- Positive active power when the downstream equipment operates as a receiver
- Reactive power, on the one hand with the same sign as active power when the equipment downstream is inductive, on the other hand with the opposite sign when the equipment downstream is capacitive

	P < 0	P > 0
Q > 0	<b>II</b> Capacitive (lead or ahead)	<b>I</b> Inductive (lag or delay)
Q < 0	<b>III</b> Inductive (lag or delay)	<b>IV</b> Capacitive (lead or ahead)

**Setting the reactive and apparent power calculation convention**

This parameter is used to configure the convention for calculating total reactive power and total apparent power.

The calculation of these two variables will not lead to the same value as it depends on whether the addition of the phase components is vectorial or arithmetic.

The following figure clearly shows the difference in the case of total apparent power:

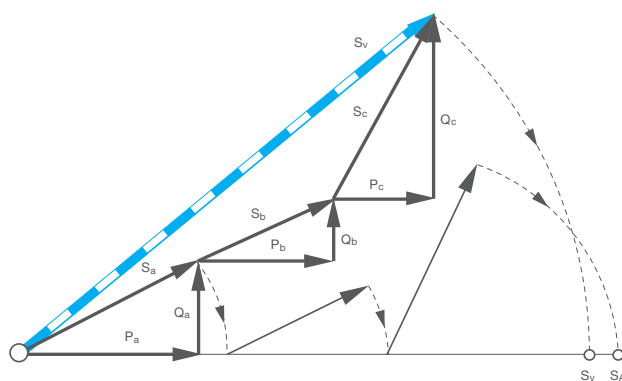

Vector and arithmetic addition



Symbol	Definition
<b>Pa</b>	Active power L1
<b>Pb</b>	Active power L2
<b>Pc</b>	Active power L3
<b>Qa</b>	Reactive power L1
<b>Qb</b>	Reactive power L2
<b>Qc</b>	Reactive power L3
<b>Sa</b>	Apparent power L1
<b>Sb</b>	Apparent power L2
<b>Sc</b>	Apparent power L3
<b>SV</b>	Total apparent power: Vector addition
<b>SA</b>	Total apparent power: Arithmetic addition

On the figure above, the value of total apparent power SA by arithmetic addition is greater than the value of total apparent power SV by vector addition.

Calculation convention setting	Default setting
Arithmetic – Vector	Vector

List of values affected by the calculation convention setting.

Value	Definition
<b>Qtot</b>	Total reactive power
<b>Stot</b>	Total apparent power
<b>ErIn</b>	Reactive energy consumed
<b>ErOut</b>	Reactive energy generated
<b>Er Abs</b>	Absolute reactive energy
<b>Er</b>	Signed reactive energy value
<b>Es</b>	Apparent energy
<b>PF1</b>	Power factor L1
<b>PF2</b>	Power factor L2
<b>PF3</b>	Power factor L3
<b>PFtot</b>	Total power factor
<b>cos φ tot</b>	Cos φ total
<b>Qtot Dmd</b>	Averaged value (over interval) of total reactive power
<b>Stot Dmd</b>	Averaged value (over interval) of total apparent power
<b>Max Qtot Dmd</b>	Max. averaged value (over interval) of total reactive power
<b>Max Stot Dmd</b>	Max. averaged value (over interval) of total apparent power

#### Setting the power factor and $\cos\varphi$ sign convention

This parameter is used to configure the sign for power factors and  $\cos\varphi$  according to the IEC convention or the IEEE convention in the four-quadrant diagram.

IEC convention

	P < 0	P > 0
Q > 0	<b>ii</b> Capacitive (lead or ahead)  PF < 0	<b>I</b> Inductive (lag or delay)  PF > 0 cos $\varphi$ > 0
Q < 0	<b>III</b> Inductive (lag or delay)  PF < 0	<b>IV</b> Capacitive (lead or ahead)  PF > 0 cos $\varphi$ > 0

The IEC convention is indicated when the equipment downstream of the circuit breaker may operate in turn as a receiver and as a generator.

IEEE convention

	P < 0	P > 0
Q > 0	<b>ii</b> Capacitive (lead or ahead)  PF > 0	<b>I</b> Inductive (lag or delay)  PF < 0 cos $\varphi$ < 0
Q < 0	<b>III</b> Inductive (lag or delay)  PF < 0	<b>IV</b> Capacitive (lead or ahead)  PF > 0 cos $\varphi$ > 0

PF sign convention setting	Default setting
IEC - IEEE	IEC

**Setting the averaged value over interval (Demand value) parameters**

This parameter is used to configure the length of the integration interval and the type of integration in order to perform the averaged value (Demand value) calculations correctly.

Calculating the averaged values over a specific interval involves integrating the currents and powers over a time interval (see § 3.3.7).

Request Period Setting	Default setting
5 – 60 min. (increments of 1 min.)	30 min.

Request Mode Setting	Default setting
Fixed – Sliding – Sync. Bus	Fixed

**Note**

The parameter "Request Period" is not taken into account in the average value calculation if the "Request Mode" setting (type of integration interval) is Sync. Bus (Synchronised integration interval).

The Energy trip unit complies with the requirements of standard IEC 61557-12 Edition 1:

- Class 0.5 for measuring currents and voltages,
- Class 1 for measuring active energy.

The accuracy of each measurement is defined, in accordance with IEC 61557-12, for a supply within normal ambient temperature conditions of 23 °C ± 2 °C.

**3.3.11 Accuracy of measurements**

For a measurement taken at another temperature, within the temperature range of - 25 °C...+ 70 °C, the temperature accuracy derating coefficient is 0.05% per °C. The accuracy range is the part of the measuring range for which the defined accuracy is obtained; the definition of this range may be related to the load characteristics of the circuit breaker.

Variables	Symbols	Measuring range	Class IEC 61557-12 or accuracy
Currents and Max./Min. current	I1, I2, I3; IN, Iavg, Imax, Imin,...	0.2...1.2 x In	0.5
Ground fault	% IG	0.2...1.2 x In	0.5
Current unbalance	I1 Unb, I2 Unb, I3 Unb; IN Unb, Max Unb I	-	-
Phase-phase and Min/Max voltages	U12, U23, U31, Uavg	120 V - 690 V	0.5
Phase-neutral and Min/Max voltages	V1N, V2N, V3N, Vavg	70 V - 440 V	0.5
Unbalance	U12 Unb, U23 Unb, U31 Unb, V1N Unb, V2N Unb, V3N Unb, Max Unb U, Max Unb V	0.8...1.2 x Vn	-
Frequency	f	45 Hz - 65 Hz	0.02
Power	P total, P per phase, Q total, Q per phase, S total, S per phase	0.05...1.2 x In	1
Active energy	Ealn, EaOut, Ea Abs, Ea, Ealn EaOut	0.05...1.2 x In	1
Reactive energy	ErIN, ErOut, Er Abs, Er	0.05...1.2 x In	2
Apparent energy	Es	0.05...1.2 x In	1
Average powers over interval (Demand powers)	P Dmd per phase, P Dmd Total, Q Dmd per phase, Q Dmd Total, S Dmd per phase, S Dmd Total Max P Dmd per phase, Max P Dmd Total, Max Q Dmd per phase, Max Q Dmd Total, Max S Dmd per phase, Max S Dmd Total	0.05...1.2 x In	1
Average currents over interval (Demand currents)	I1 Dmd, I2 Dmd, I3 Dmd, IN Dmd, Iavg Dmd, Max I1 Dmd, Max I2 Dmd, Max I3 Dmd; Max IN Dmd, Max I1 Dmd, Max I2 Dmd, Max I3 Dmd; Max IN Dmd	0.2...1.2 x In	0.5
Power factors	PF1, PF2, PF3, PFtot, Cos φ1, Cos φ 2, Cos φ 3, Cos φ tot	0.5 inductive to 0.8 capacitive	1
Voltage THD	THDU (ph.-ph.), THDV (ph.-N)	0...20%	2
Current THD	THDI per phase	0...200%	2

### 3.4.1 Principle of Energy trip unit alarms

The Energy trip unit is used to manage four types of alarms:

- PTA overload pre-alarm
- Trip alarm
- Customisable alarm
- System alarm

The PTA overload **pre-alarm** provides a warning about the imminent trip risk due to a current overload. It is associated with the PTA output contact.

The **trip alarms** provide warning about trip events and guide diagnostics towards the cause of the trip.

The **customisable alarms** are used to monitor and be alerted to the measurements taken by the Energy trip unit.

The **system alarms** correspond to predefined events.

In addition to these alarms, the OAC output contact alarm enables one of the following alarms to be reported: PTA overload pre-alarm, customisable alarms, system alarms.

#### Priority level of customisable and trip alarms

Each trip alarm and each customisable alarm is associated with a priority level:

- High priority
- Medium priority
- Low priority
- No priority

The trip alarms and customisable alarms created are always in operation, even if no priority has been assigned.

The overload pre-alarm, the system alarms and the OAC output contact alarm are always in operation and have the high priority level.

#### Signalling of alarms on the Energy trip unit

	PTA LED	Pop-up
PTA overload pre-alarm	X	-
Trip alarm	-	X
System alarm	-	X
OAC output alarm	-	X

#### Note

The customisable alarms are not reported on the Energy trip unit. The "Internal trip unit error" system alarm is identified by the "Ready" LED which flashes orange (see 3.4.5 below).

#### Signalling of alarms on the panel display

	Stored in the log	Stored in the list of active alarms	Pop-up	Alarm LED
<b>Priority level</b>				
low	X	-	-	-
medium	X	X	-	X
high	X	X	X	X

3.4.2  
PTA overload pre-alarm

The PTA overload pre-alarm is defined by two parameters:

- PTA threshold: Threshold expressed as a % Ir (can be adjusted from 60 to 95%)
- PTA time delay: Expressed as a % tr (can be adjusted from 5 to 80%)

It is activated for a load current when the intensity and duration falls in a **pre-trip warning zone**.

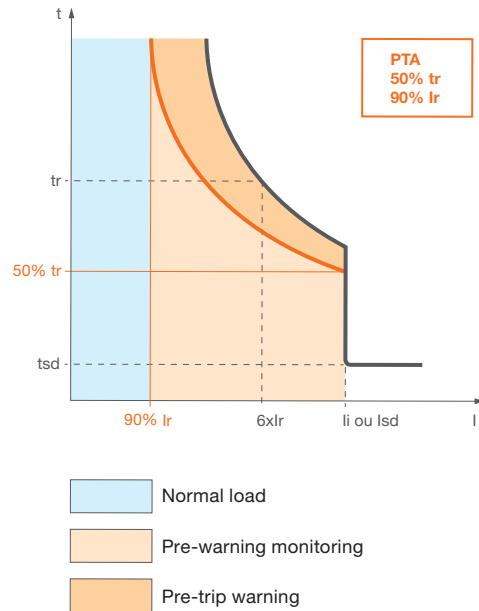

Overload pre-alarm zones

This **pre-trip warning zone** is delimited on the one hand by the threshold and time delay of the PTA overload pre-alarm and, on the other hand, by the Ir threshold and tsd time delay.

The **pre-warning monitoring zone** starts from the PTA threshold. Any load current which appears in the monitoring zone is taken into account in the form of a thermal image of current and increases as the load of the Energy trip unit increases.

When the monitoring zone is entered and the PTA overload pre-alarm is active, the PTA LED for the trip unit is activated.

Activation of the overload pre-alarm also results in the PTA output contact closing.

	Normal load zone	Pre-warning monitoring zone	Pre-trip warning zone
<b>PTA</b> [LED indicator]	off	Flashing orange	Permanent orange
PTA contact	open	open	closed

**Note**

This pre-alarm and the behaviour described above are also the same for LSI and LSIG circuit breakers. The LED corresponding to these circuit breakers is 90% Ir.

### 3.4.3 Trip alarms

The trip alarms indicate a trip event and provide information about its cause.

The possible causes of tripping are:

- Trip related to long time delay protection
- Trip related to short time delay protection
- Trip related to instantaneous protection
- Trip related to ground fault protection
- Trip during test (see HTP610H configuration tool)

The following information is provided in the case of the message for a trip alarm:

- Trip cause
- Phase concerned by the fault (only for long time delay, short time delay and instantaneous causes)
- Fault current value (only long time delay, short time delay, instantaneous and ground causes)

#### Last trip

Information regarding the last trip is systematically stored, regardless of the priority associated with the alarm. This information can be accessed via communication devices, but also in the **Information** menu of the embedded display.

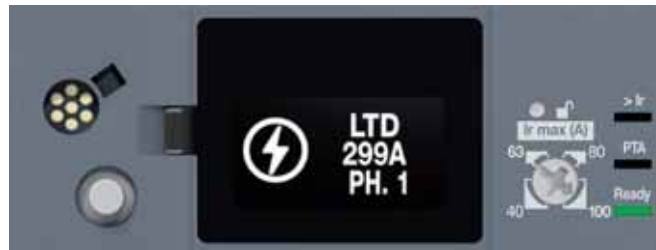

Trip alarm on embedded display

3.4.4 Customisable alarms

Customisable alarms make it possible to monitor any measuring event detected by the Energy trip unit. It is possible to define up to 12 alarms for a single trip unit. Each alarm is dedicated to monitoring a single measurement.

A custom alarm is defined through the following parameters:

- Measurement monitored
- Activation threshold
- Deactivation threshold
- Activation time delay
- Deactivation time delay
- Priority level

**Activation condition for customisable alarms**

Activation of a custom alarm results from one of the following conditions:

- Positive breach of a threshold
- Negative breach of a threshold
- Equal to a measurement value

**Activation by positive breach**

In the case of a positive breach of a threshold, activation of the alarm is dependent on the activation threshold being positively breached.

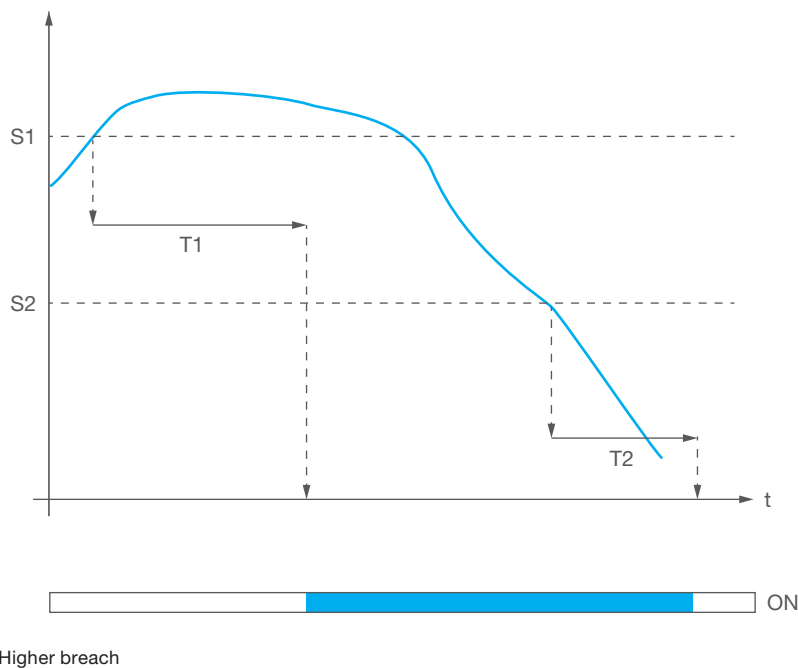

Symbol	Meaning
S1	Activation threshold
S2	Deactivation threshold
T1	Activation time delay
T2	Deactivation time delay

**Activation by negative breach**

In the case of a negative breach of a threshold, activation of the alarm is dependent on the activation threshold being negatively breached.

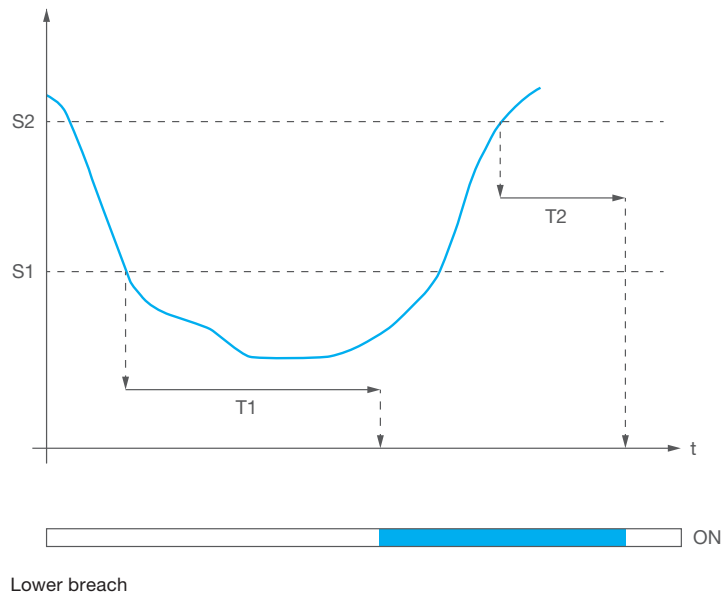

Symbol	Meaning
S1	Activation threshold
S2	Deactivation threshold
T1	Activation time delay
T2	Deactivation time delay

**Activation due to equal levels**

For the equal value condition, the alarm is activated when the value measured is the same as the activation value. The activation threshold is the same as the activation value.

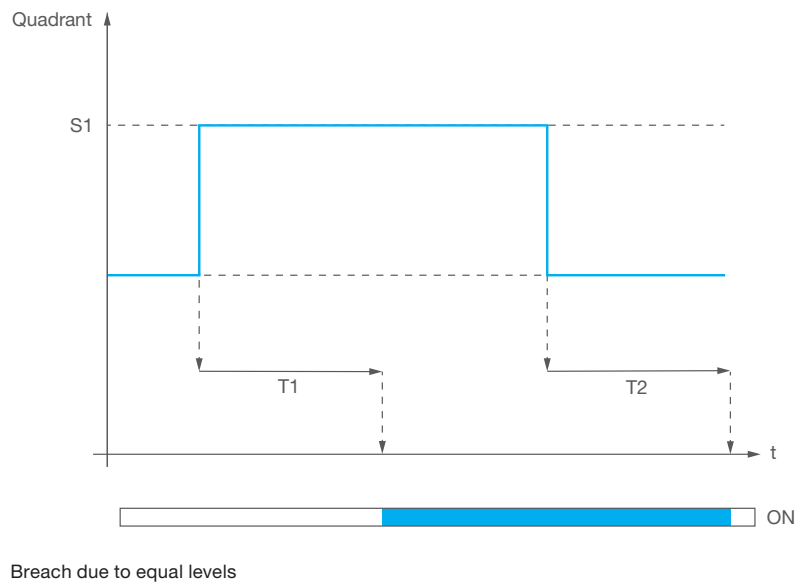



Symbol	Meaning
S1	Activation value
T1	Activation time delay
T2	Deactivation time delay

**Managing time delays**

The time delays of customisable alarms are managed by 2 counters which are normally at 0

For the activation time delay, the counter:

- Is increased when the activation condition is met
- Is decreased if the activation condition is not met and if the time delay is not reached
- Is reset when the time delay is reached

For the deactivation time delay, the counter:

- Is increased when the deactivation condition is met
- Is decreased if the deactivation condition is no longer met and if the time delay is not reached
- Is reset when the time delay is reached

When the activation time delay is reached, the alarm is activated.

When an alarm is reconfigured, the counters are also reset.

Example:

In this example, the alarm is set to a positive breach of the activation threshold of 280 V when measuring the voltage V1N. The activation time delay is set at 4 seconds. The deactivation threshold is set at 250 V and the deactivation time delay at 2 seconds.

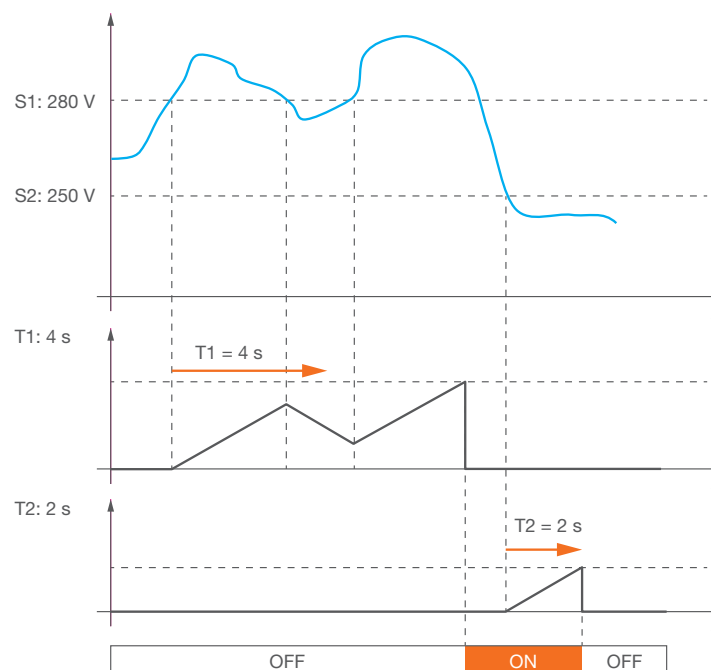

Customisable alarms: Time delays

Symbol	Meaning
S1	Activation threshold
S2	Deactivation threshold
T1	Activation time delay
T2	Deactivation time delay

3.4.5  
System alarms

There are three system alarms:

- Internal trip unit error
- Trip unit temperature alarm
- Rupture of the neutral pole

They correspond to predefined events:

**Internal trip unit error**

The Energy trip unit constantly monitors its protection function. In the case of an operating fault concerning the electronics of the trip unit, the **Internal trip unit error** alarm is activated and the circuit breaker status LED flashes orange. In that case, the MCCB is considered defective and no longer guarantees the protection of the electrical installation





**Trip unit temperature alarm**

The Energy trip unit constantly monitors its internal temperature. When the temperature exceeds 105 °C, the **trip unit temperature** alarm is activated and a pop-up appears on the embedded display and the panel display. The alarm remains active whilst the internal temperature of the trip unit remains above the threshold of 100 °C.

**Rupture of the neutral pole**

Only available on Energy 4P versions. This alarm is activated if a ruptured neutral pole is detected on an Energy 4P circuit breaker and if this alarm has been assigned to the OAC output contact. A ruptured neutral pole produces an increased voltage potential between the phase poles and the neutral pole. This detection is based on monitoring an overvoltage of approximately 275 VAC, a trip threshold and a time delay. These parameters are defined from standard EN50550 for a rated voltage between phase and neutral of 230 V.

These alarms are identified by LEDs or pop-ups depending on the trip unit version and display used:

	LSIG LSI LSnl	Energy	Panel display
<b>Internal trip unit error</b>	Flashing orange notification 		Notification "Circuit breaker error"
<b>Trip unit temperature alarm</b>	 (only LSI LSIG)	Notification 	Notification "T °C exceeded"
<b>Rupture of the neutral pole</b>	-	 OAC	Notification "Ruptured N pole"

**Note**

These system alarms can be assigned to the OAC output contact. In this case, the OAC pop-up will be added to other pop-ups on the respective displays.

**3.4.6  
Configuring alarms**

**Configuring the PTA overload pre-alarm**

The trip threshold and time delay for the PTA overload pre-alarm can be adjusted. The parameters are defined in relation to the long time delay Ir and tr parameters.

PTA threshold (% Ir)	PTA pre-alarm threshold
PTA time delay (% tr)	PTA pre-alarm time delay

PTA pre-alarm setting	Default setting	
PTA threshold (% Ir)	60 to 95 (increments of 5%)	90
PTA time delay (% tr)	5 to 80 (increments of 5%)	50

**Configuring the OAC output contact**

The OAC output contact is set using two parameters.

- Alarm allocation
- Contact behaviour

OAC output setting	Default setting	
Alarm allocation	See list.	PTA overload pre-alarm
Contact behaviour	Automatic - manual	Automatic

List of alarms available to assign to the OAC output contact:

**Alarms available**

PTA overload pre-alarm	
Custom alarm	1
Custom alarm	2
Custom alarm	3
Custom alarm	4
Custom alarm	5
Custom alarm	6
Custom alarm	7
Custom alarm	8
Custom alarm	9
Custom alarm	10
Custom alarm	11
Custom alarm	12
Internal trip unit error	
Trip unit temperature alarm	
Rupture of the neutral pole	
None	

**Contact behaviour**

In **Automatic** mode, the OAC contact will open automatically 500 ms after the alarm disappears.

In **Manual** mode, the OAC contact will remain active after the fault disappears until the alarm is cleared via the embedded display.

**Note**

To allocate the OAC contact to the PTA overload pre-alarm, the contact is forced to automatic mode and the contact opens when the alarm disappears.

**Configuring trip alarms**

Trip alarms can be configured from the HTD210H panel display, the HTP610H configuration tool and by using the Modbus connection via a HTC3x0H communication module.

The trip alarm activation and deactivation hysteresis is fixed and cannot be adjusted. Only the priority level setting is necessary.

Trip alarm setting		Default setting
Priority level	None – low – medium - high	High

**Note**

The trip alarms are signalled by a pop-up message on the embedded display of the Energy trip unit regardless of the priority level setting.

**Configuring custom alarms**

Custom alarms can be configured from the embedded display and the HTP610H configuration tool.

For all alarms, the activation and deactivation time delays can be set between 1 and 3000 seconds, at one-second increments.

Measurement monitored	Possible activation conditions	Activation/ deactivation threshold ranges	Version 3P	Version 4P
<b>Currents</b>				
Currents I1, I2, I3, Iavg	> <	0.2 x In to 10 x In (increments of 0.1 A)	X	X
I <sub>max</sub> current	>	0.2 x In to 10 x In (increments of 0.1 A)	X	X
I <sub>N</sub> current	> <	0.2xIn to 10 x In (increments of 0.1 A)	-	X
I <sub>G</sub> current	>	10% x I <sub>g</sub> to 100% x I <sub>g</sub> (increments of 1%)	X	X
Current unbalances	>	5% to 60%, (increments of 0.1%)	X	X
<b>Voltages</b>				
Voltages V1, V2N, V3N, Vavg	> <	80 V to 800 V (increments of 1 V)	-	X
Voltage V <sub>max</sub>	>	80 V to 800 V (increments of 1 V)	-	X
Voltage V <sub>min</sub>	<	80 V to 800 V (increments of 1 V)	-	X
Phase-to-neutral voltage unbalances	>	2% to 30% (increments of 0.1%)	-	X
Voltages U12, U23, U31	> <	80 V to 800 V (increments of 1 V)	X	X
Voltage U <sub>max</sub>	>	80 V to 800 V (increments of 1 V)	X	X
Voltage U <sub>min</sub>	<	80 V to 800 V (increments of 1 V)	X	X
Line-to-line voltage unbalances	>	2% to 30% (increments of 0.1%)	X	X

Measurement monitored	Possible activation conditions	Activation/deactivation threshold ranges	Version 3P	Version 4P
<b>Power</b>				
Active power consumed per phase	> <	1 kW to 1000 kW (increments of 0.1 kW)	-	X
Total active power consumed	> <	1 kW to 3000 kW (increments of 0.1 kW)	X	X
Active power generated per phase	> <	1 kW to 1000 kW (increments of 0.1 kW)	-	X
Total active power P	> <	1 kW to 3000 kW (increments of 0.1 kW)	X	X
Reactive power consumed per phase Q1, Q2, Q3	> <	1 kvar to 1000 kvar (increments of 0.1 kvar)	-	X
Total reactive power consumed Q	> <	1 kvar to 3000 kvar (increments of 0.1 kvar)	X	X
Reactive power returned per phase Q1, Q2, Q3	> <	1 kvar to 1000 kvar (increments of 0.1 kvar)	-	X
Total reactive power returned Q	> <	1 kvar to 3000 kvar (increments of 0.1 kvar)	X	X
Apparent power per phase S1, S2, S3	> <	1 kVA to 1000 kVA (increments of 0.1 kVA)	-	X
Total apparent power S	> <	1 kVA to 3000 kVA (increments of 0.1 kVA)	X	X
Capacitive power factor per phase	<	0 to 0.99 (increments of 0.01)	-	X
Total capacitive power factor	<	0 to 0.99 (increments of 0.01)	X	X
Inductive power factor per phase	<	0 to 0.99 (increments of 0.01)	-	X
Total inductive power factor	<	0 to 0.99 (increments of 0.01)	X	X
<b>Cos phi</b>				
Capacitive cos phi per phase	<	0 to 0.99 (increments of 0.01)	-	X
Total capacitive cos phi	<	0 to 0.99 (increments of 0.01)	X	X
Inductive cos phi per phase	<	0 to 0.99 (increments of 0.01)	-	X
Total inductive cos phi	<	0 to 0.99 (increments of 0.01)	X	X
<b>Distortion level</b>				
Total harmonic distortion of current per phase THDI1, THDI2, THDI3	>	0% to 1000% (increments of 0.1%)	X	X
Total harmonic distortion of phase-neutral voltages THDV1N, THDV2N, THDV3N	>	0% to 1000% (increments of 0.1%)	-	X
Total harmonic distortion of phase-phase voltages THDU12, THDU23, THDU31	>	0% to 1000% (increments of 0.1%)	X	X

Measurement monitored	Possible activation conditions	Activation/deactivation threshold ranges	Version 3P	Version 4P
<b>Average currents over interval (Demand currents)</b>				
I1_dmd, I2_dmd, I3_dmd, lavg_dmd	> <	0.2xIn to 10xIn (increments of 0.1 A)	X	X
Current request IN_dmd	> <	0.2xIn to 10xIn (increments of 0.1 A)	-	X
<b>Averaged power over interval (Demand power)</b>				
Total active power Pdmd	> <	1 kW to 3000 kW (increments of 0.1 kW)	X	X
Total reactive power Qdmd	> <	1 kvar to 3000 kvar (increments of 0.1 kvar)	X	X
Total apparent power Sdmd	> <	1 kVA to 3000 kVA (increments of 0.1 kVA)	X	X
<b>Frequency</b>				
Frequency	> <	45 Hz to 65 Hz (increments of 0.01 Hz)	X	X
<b>Quadrant</b>				
Operating quadrant 1	=	-	X	X
Operating quadrant 2	=	-	X	X
Operating quadrant 3	=	-	X	X
Operating quadrant 4	=	-	X	X
<b>Field</b>				
Direct rotating field	=	-	X	X
Indirect rotating field	=	-	X	X
<b>Lead or lag circuit</b>				
Capacitive circuit (lead)	=	-	X	X
Inductive circuit (lag)	=	-	X	X

### 3.4.7 Alarm log

The Energy trip unit has an internal memory to enable the following logs to be stored:

- Trip alarm log (up to 10 events)
- Custom alarm log (up to 40 events)
- Log of modifications to trip unit protection settings (up to 5 events per protection parameter)

These logs are updated after each event.

#### Trip alarm log

Each trip event is saved with the following information:

- Trip cause
- Phase concerned by the fault (only for long time delay, short time delay and instantaneous causes)
- Fault current value (only long time delay, short time delay, instantaneous and ground causes)
- User time
- Machine time

**Custom alarm log**

Each custom alarm event is saved with the following information:

- Description
- User time
- Machine time
- Alarm appearance/disappearance

**Log of protection settings**

Every modification to one of the protection settings is saved in the log:

- lr
- tr
- Short time delay activation
- lsd
- tsd
- I<sup>2</sup>t on tsd
- ZSI short time delay (only on Energy P250)
- li
- Ground protection activation
- lg
- tg
- I<sup>2</sup>t on ground fault
- ZSI ground fault (only on Energy P250)
- Neutral activated/deactivated (only on version 4P)
- Neutral setting coefficient (only on version 4P)

Every modification to a protection setting is saved with the following information:

- Previous setting
- User time
- Machine time

For each setting, up to 5 modifications can be saved separately. When a setting is modified, the previous value is saved as well as the user time and machine time.

These logs can be accessed from the modbus communication, the panel display and the HTP610H configuration tool.

The configuration tool is used to clear the trip alarm and custom alarm logs:

- In full
- At high priority
- At medium priority
- At low priority

**Machine time**

The machine time counts the total operating time of the trip unit. It is given in absolute time and cannot be adjusted.

The machine time increases when the trip unit is in service. The increase is interrupted when the trip unit is no longer supplied.

It is not recommended to use the machine time as a clock to record the time of the log events.

**User time**

The user time can be adjusted manually (via the embedded display or the panel display) or by synchronising it with a reference clock from the configuration tool or by a Modbus control. It is given in the form of the date, hours, minutes and seconds. Just like the machine time, the counter increases when the trip unit is supplied correctly.

By default, the date is set at 1st January 2000, and is reset when the trip unit is no longer supplied (no self-supply or external supply).

**Note**

It is recommended to use an external supply so that the user time is consistent, or to ensure that when using a communication bus, the monitoring system performs another synchronisation at each start-up.

If using the Energy circuit breaker without a communication bus or without an external supply, the machine time can still save the chronology of the events appearing in the log.



# Starting, commissioning, operation

Page

---

<b>4.1 Plug connections and accessories</b>	<b>74</b>
4.1.1 Plug connections	74
4.1.2 Connection accessories	75
<hr/>	
<b>4.2 Starting and configuring the circuit breaker</b>	<b>76</b>
4.2.1 Precautions for use before starting	76
4.2.2 Starting the Energy trip unit for the first time	78
4.2.3 Setting the max Ir setpoint and Ir current of the Energy trip unit	79
4.2.4 Configuration via the unlock button	82
4.2.5 Configuring Live mode	85
<hr/>	
<b>4.3 Connecting the communication module</b>	<b>86</b>
4.3.1 Connecting the module to the circuit breaker	86
4.3.2 Connecting the communication module supply	88
4.3.3 Connecting inputs/outputs	88
<hr/>	
<b>4.4 Assembling and connecting the AX/AL Energy auxiliary</b>	<b>89</b>
<hr/>	
<b>4.5 Connecting the PTA and OAC output contacts</b>	<b>91</b>
4.5.1 Connecting the PTA contact	91
4.5.2 Connecting the OAC contact	92
<hr/>	
<b>4.6 Start-up and configuration via the HTD210H display</b>	<b>93</b>
4.6.1 Overview of the HTD210H display	93
4.6.2 Connecting the HTD210H display	95
4.6.3 HTD210H display supply	96
4.6.4 Starting the HTD210H display for the first time	97
4.6.5 Configuration recommendations via HTD210H	100
4.6.6 Text block: Activation of HTD210H alarms	102
<hr/>	
<b>4.7 Commissioning via the HTP610H configuration tool</b>	<b>104</b>
4.7.1 Preparing the HTP610H tool	105
4.7.2 Configuration recommendations via HTP610H	108
4.7.3 Trip curve test via HTP610H	110
4.7.4 PTA and OAC contact test via HTP610H	111
<hr/>	
<b>4.8 Operation</b>	<b>112</b>
4.8.1 Displaying information on the embedded and panel display	112
4.8.2 Displaying data on the HTP610H configuration tool	114
4.8.3 Displaying operating data on agardio.manager	115

4.1.1  
Connectors

The Energy circuit breaker is equipped with specific connectors for connecting communication devices and accessories.

**PTA connector:** Used to connect the PTA output contact to send the overload pre-alarm over a local signalling circuit.

**OAC connector:** The OAC port is an output contact used to send the optional alarm over a local signalling circuit.

**MIP connector:** Used to temporarily connect the HTP610H configuration tool.

**CIP connector:** These two ports are used to connect the HTD210H display, an external 24 VDC supply or the communication module as required.

**ACP connector:** Used to connect the AX/AL Energy auxiliary.

**ZSI1 connector:** Present only on P250 versions and used to connect the downstream circuit breakers to implement zone selective interlocking (ZSI).

**ZSI2 connector:** Present only on P160 and P250 versions and used to connect the upstream circuit breaker to implement zone selective interlocking (ZSI).

Availability of connectors according to electronic trip unit version:

	LSnl	LSI	LSIG	Energy
PTA	-	X	X	X
OAC	-	-	-	X
MIP	X	X	X	X
CIP	-	-	-	X
ACP	-	-	-	X
ZSI1	-	-	-	P250 only
ZSI2	-	-	-	X

**Location of connectors**

Energy P160 circuit breaker version



Energy P160 trip unit connectors

Energy P250 circuit breaker version



Energy P250 trip unit connectors

Location of the PTA connector



PTA connector

4.1.2  
Connection accessories

Connection accessories are available as an option. These are pre-wired adapters which are available in various lengths as required.

Connector	Accessories reference	length
<b>PTA or OAC</b>	HTC130H: OAC/PTA adapter	1,20 m
<b>MIP</b>	Included in the HTP610H tool	–
<b>CIP</b>	HTC330H: CIP adapter	0,50 m
	HTC340H: CIP adapter	1,50 m
	HTC350H: CIP adapter	3 m
	HTC360H: CIP adapter	5 m
	HTC370H: CIP adapter	10 m
	HTC140H: CIP adapter – 24 V	1,20 m
<b>ACP</b>	HXS120H: AX/AL Energy (AX and AL contacts cannot be connected)	–
	HXS121H: AX/AL Energy 230 VAC	–
	HXS122H: AX/AL Energy 125 VAC / 30 VDC	–
<b>ZSI1 or ZSI2</b>	HTC150 H: ZSI adapter	1,20 m

Identifying the wires of HTC130H, HTC140H, HTC150H adapters and HXS12xH auxiliaries

	Number of output wires	Identification of wires	
<b>HTC130H HTC140H</b>	2 wires	+ polarity: Brown - polarity: White	
<b>HXS121H HXS122H</b>	6 wires	<b>AX contact</b> Shared: White NO: Black NF: Red	<b>AL contact</b> Shared: White NO: Black NF: Red
<b>HTC150H</b>	3 wires	Shared: Brown Short time delay signal: White Ground fault signal: Green	

4.2.1  
Precautions for use before starting

 <b>DANGER</b>
<p><b>Risk of serious injury or danger of death.</b> Ensure that the power supply inlet upstream of the circuit breaker is cut off and isolated before connecting the accessories and devices for the communication system.</p>

Please respect the recommendations and instructions for installing the Energy circuit breaker. To do this, please refer to the technical documentation for the range of h3+ circuit breakers as well as the installation manual supplied with the circuit breaker.

**Choosing the external 24 VDC supply**

An external 24 VDC supply is required to supply the communication accessories and to guarantee that the measurement, alarm and configuration functions of the Energy trip unit always function correctly. It is recommended to use a 24 VDC SELV supply (Safety Extra Low Voltage).

This external supply must be high enough to meet the needs of the accessories connected.

**Consumption of various accessories**

Energy trip unit	60 mA
HTD210H panel display	85 mA
HTC310H/HTC320H communication module	40 mA

The HTG911H 24 V supply fully meets these needs as it is SELV and provides an output current up to 2.5 A.

**Note**

In addition, it is recommended to use a secure 24 VDC supply to guarantee complete continuity of service and correct operation even in the event of a distribution network failure.

**Reminder:**

Minimum conditions for which the measurement, alarm and configuration functions are available without an external supply:

- Circuit breaker closed
- minimum current through the circuit breaker; below is a table per rating

Rating	1 pole supplied	2 poles supplied	3 poles supplied
40 A	NA	>14 A	>10 A
100 A	>25 A	>15 A	>15 A
160 A	>32 A	>16 A	>16 A
250 A	>50 A	>25 A	>25 A

**Connecting the 24 VDC external supply**

The external 24 VDC supply is connected to the circuit breaker in two ways:

- Direct connection with HTC140H CIP-24V adapter
- Connection via the communication module

Here is the procedure to follow in order to connect the supply directly to the CIP connector:

	Action	Note
1	Switch the Energy circuit breaker to the OFF or tripped position.	
2	Open the front cover of the circuit breaker.	The front cover of the circuit breaker can only be opened in the OFF or tripped position.
3	Insert the CIP connector for the HTC140H adapter in one of the connectors marked CIP inside the circuit breaker on the left-hand side	<ul style="list-style-type: none"> <li>- Risk of damaging the CIP connector.</li> <li>- Respect the direction of insertion for the connector: The adapter part marked CIP must be visible from the front.</li> <li>- Avoid forcing the connector when inserting.</li> </ul>
4	Route the cable for the HTC140H adapter along the left-hand side cable channel of the circuit breaker provided for this purpose.  If necessary, use the side support supplied with the circuit breaker to connect the cable to the side wall (see illustration below).	<p>it is advisable to provide a 24 V connection terminal near the circuit breaker to connect the + and – wires for the HTC140H adapter. The wiring of the 24 VDC circuit may be extended from this terminal up to the 24 VDC supply terminals.</p> <ul style="list-style-type: none"> <li>+ wire: Brown colour</li> <li>- wire: White colour</li> </ul> <p>Please respect the wiring rules in force in switchboards:</p> <ul style="list-style-type: none"> <li>- Separate the routing of the power cables and the circulation of low-level signal cables</li> <li>- Secure the cable along the routing.</li> </ul>
5	Close the front cover of the circuit breaker to immobilise the side support as well as the side cable routing.	

**Routing the HTC140H cable using the side support.**



CIP cables and side support

4.2.2  
Starting the Energy trip unit  
for the first time

At first start-up, before being able to access the various menus, the embedded display will ask the user to set the orientation, brightness and Standby mode. These settings can be confirmed using the joystick on the left-hand side of the display.

Once the correct setting has been selected, press the joystick to confirm the setting and move on to the next screen.

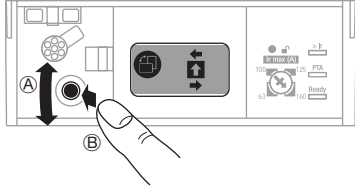
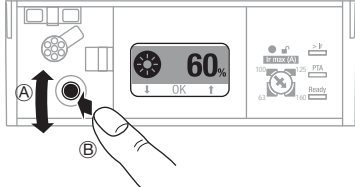
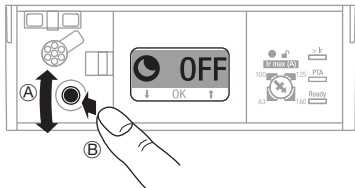
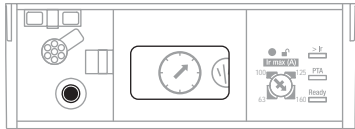
	Action	Note/Illustration
1	<b>Orientation of the display</b>	
	<p>(A) Push the joystick upwards or downwards to select the orientation of the display.</p> <p>(B) Press the joystick to confirm the choice</p>	
2	<b>Setting the screen brightness</b>	
	<p>(A) Push the joystick upwards or downwards to select the brightness.</p> <p>(B) Press the joystick to confirm the choice</p>	
3	<b>Activating/deactivating Standby mode</b>	
	<p>(A) Push the joystick upwards or downwards to activate/deactivate Standby mode.</p> <p>(B) Press the joystick to confirm the choice</p>	
4	<b>Navigation through the main menus</b>	

After these three settings are confirmed, the Main menu is displayed.

**4.2.3**  
**Setting the max Ir setpoint**  
**and Ir current of the Energy**  
**trip unit**

After having set the display, the Ir max setpoint and Ir current should be set. Proceed as follows.

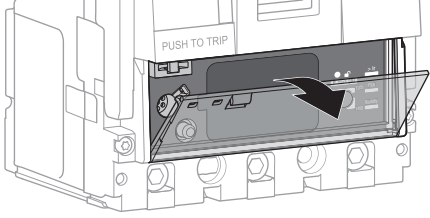
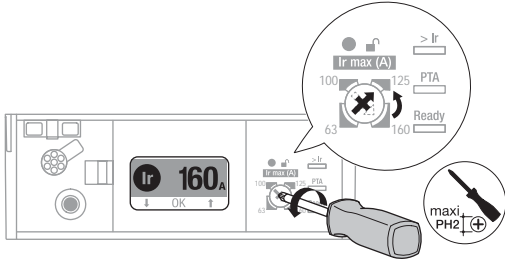
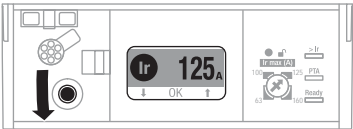
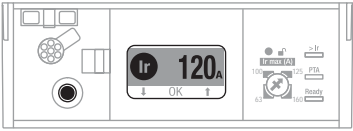
	Action	Note/Illustration
1	Open the transparent flap in order to access the max Ir adjustment dial	
2	Move the max Ir adjustment dial using a PH1, PH2 or PZ2 size screwdriver. Position the adjustment dial on the maximum desired value for Ir.	 <p><b>Note</b> The display automatically switches to Unlocked mode and asks you to modify the Ir value. The Ir value is then displayed in inverted colours and the icon and value pair is displayed with a background in the inverted colour</p>
3	Move the navigation joystick downwards to fine-tune the Ir value.	
4	Press the centre of the joystick to confirm the new value.	

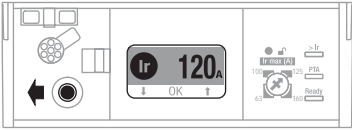
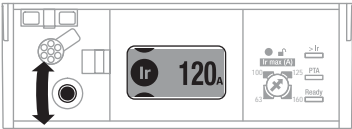
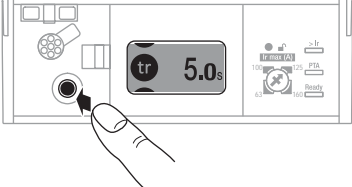
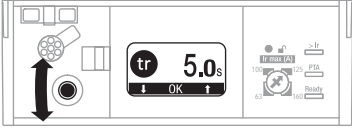
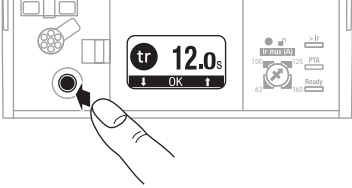
	Action	Note/Illustration
5	<p>At this stage it is possible to modify the other protection settings. To do this, it is important to remain in Unlocked mode</p>	 <p><b>Note</b> Check that the entire setting parameters icon to the left of the setting value remains displayed in the inverted colour</p>
6	<p>Move the navigation joystick upwards or downwards to select another setting parameter.</p>	
7	<p>Press the centre of the joystick to confirm the selection. The display will immediately ask you to change the value selected.</p>	
8	<p>Move the navigation joystick upwards or downwards to perform the setting.</p>	
9	<p>Press the centre of the joystick to confirm the new value</p>	



	Action	Note/Illustration
10	Repeat steps 5 to 9 to perform another protection setting	
11	Move the joystick to the left to exit Unlocked mode and return to the Main menu.	 <p>The diagram shows a control panel with a joystick on the left side. An arrow points to the left from the joystick, indicating the direction of movement. The panel also features a central display screen and various indicator lights and buttons on the right side.</p>

**Note**

This procedure is used to change the protection settings for the trip unit only. Other modifications to the settings such as resetting the maximum measurement values, returning to factory configurations or authorising data write permission, can be performed via the unlock button.

If there is no movement on the navigation joystick for more than 30 seconds, Locked mode is activated automatically again.



### 4.2.4 Configuration via the unlock button

After setting the max Ir setpoint, it is necessary to:

- Set the other protection parameters for the circuit breaker
- Set the trip unit clock
- Possibly lock the circuit breaker configuration

Proceed as follows:

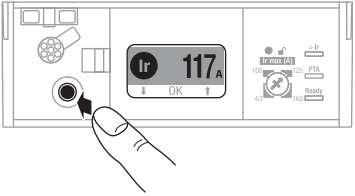
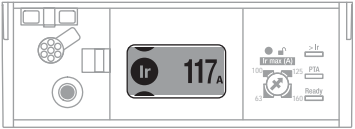
	Action	Note/Illustration
1	Open the transparent flap in order to access the unlock button.	
2	Move the joystick to the left or right to select the menu (Protection or Configuration) containing the parameter to be set.	
3	Press the centre of the joystick to access the menu.	
4	Move the joystick upwards or downwards to select the parameter to be set.	
5	Briefly press the unlock button using a rounded tip such as a ballpoint pen.	
		<p><b>Note</b></p> <p>The embedded display automatically switches to Unlocked mode. The parameter icon found to the left of the value to be set is then displayed in inverted colours.</p>
6	Move the navigation joystick upwards or downwards to select the desired value or method.	

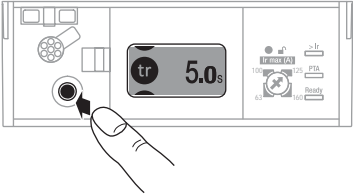
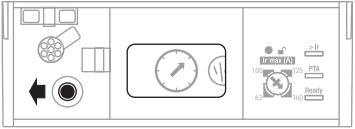
	Action	Note/Illustration
7	Press the centre of the joystick to confirm the new setting	
8	At this stage it is possible to modify other settings of the current menu. To do this, it is important to remain in Unlocked mode	 <p><b>Note</b> Check that the entire setting parameters icon to the left of the setting value remains displayed in the inverted colour</p>
9	Move the navigation joystick upwards or downwards to select another setting parameter	
10	Press the centre of the joystick or move it to the right to reverse the background colour of the icon and value assembly. The display will then ask you to modify the value or the method selected.	
11	Repeat steps 6 and 7.	
12	Move the joystick to the left to exit Unlocked mode and return to the Main menu.	

**Note**

If there is no movement on the navigation joystick for more than 30 seconds, Locked mode is automatically activated again.

**Information about setting the data write permission**

In order to enable or prohibit external devices from modifying the internal trip unit parameters (protection, measurement, configuration, etc.), it is possible to set data write permission.

The setting is performed via the **Configuration** menu of the embedded display:



Data write permission

Setting the data write permission	Default setting
ON - OFF	ON

**Note**

The "ON" value means that data write permission is activated for remote devices. The "OFF" value means that write permission is prohibited. Follow the procedure at the start of the paragraph to perform this setting.

4.2.5  
Configuring Live mode

Live mode is deactivated by default.

To manage favourites, proceed as follows:

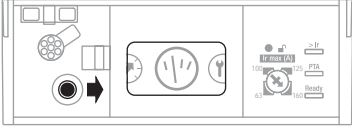
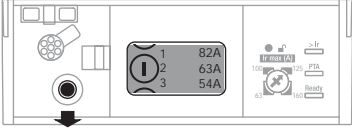
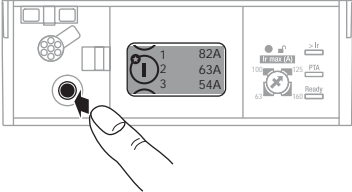
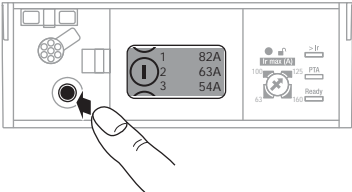
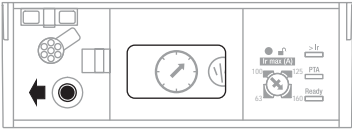
	Action	Note/Illustration
1	Move the joystick to the right to select the Measurements menu. Then press the joystick to access the Measurements menu.	
2	Move the navigation joystick downwards to select the view to be set as the favourite.	
3	Briefly press the centre of the joystick to confirm the selection. A star appears on the measurements icon to confirm the validation.	
4	Repeat steps 2 and 3 to add other favourites.	
5	Briefly press the centre of the joystick on a view confirmed as a favourite in order to delete this favourite. The star disappears on the measurements icon to confirm the validation.	
6	Move the joystick to the left to return to the Main menu.	

**Note**

Live mode starts automatically after 30 seconds of inactivity.

4.3.1  
Connecting the module to  
the circuit breaker

The communication module is connected to the Energy circuit breaker using the CIP adapter. The CIP adapter cable is composed of an RJ9 connector to connect to the communication module and a suitable connector to connect to the CIP connector.



Communication module connection

Here is the procedure to follow to connect the communication module:

	Action	Note/Illustration
1	Switch the Energy circuit breaker to the OFF or tripped position.	
2	Open the front cover of the circuit breaker.	The front cover of the circuit breaker can only be opened in the OFF or tripped position.
3	Insert the CIP connector for the CIP adapter in one of the connectors marked CIP inside the circuit breaker on the left-hand side	Risk of damaging the CIP connector. Respect the direction of insertion for the connector: The adapter part marked CIP must be visible from the front. Avoid forcing the connector when inserting.
4	Route the cable for the CIP adapter along the left-hand side cable channel of the circuit breaker provided for this purpose.  If necessary, use the side support supplied with the communication module to connect the cable to the side wall (see illustration below).	Please respect the wiring rules in force in switchboards: - Separate the routing of the power cables and the circulation of low-level signal cables - Secure the cable along the routing.

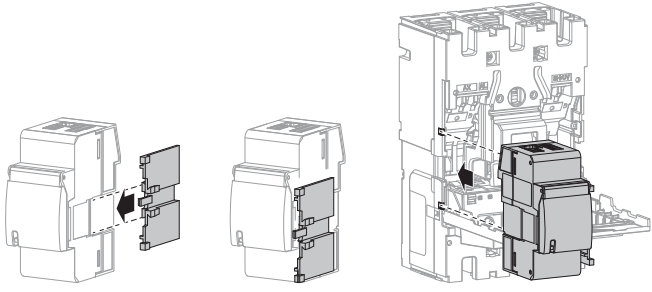
	Action	Note/Illustration
5	<p>Secure the side support to the communication module.</p> <p>Then slide the assembly along the left-hand side cable channel of the circuit breaker.</p> <p>Insert the RJ9 connector for the adapter in the connector provided for this purpose at the top of the communication module.</p>	<p>The communication module can be fitted on a DIN rail or directly on the side of the circuit breaker using the side support.</p> 
6	<p>Insert the RJ9 connector for the adapter in the connector provided for this purpose at the top of the communication module</p>	

**Routing the cable for the CIP adapter using the side support**

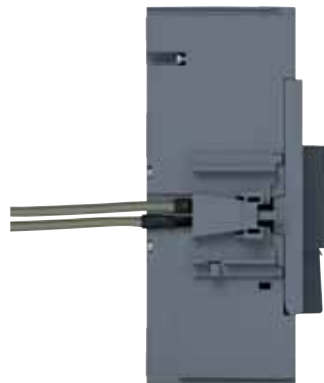

CIP cables and side support



Communication module on side support

The h3+ side support can also be used to guide the cables from inside the Energy circuit breaker such as the CIP adapters or the OAC cable.

### 4.3.2 Connecting the communication module supply

The external 24 VDC supply is connected to the communication module at the top of the module to the 24 V  $\overline{\text{---}}$  (+ / -) terminal.



HTC320H connection terminals

Cross-section of the 24 V  $\overline{\text{---}}$  (+ / -) terminal: 0.5 to 1.5 mm<sup>2</sup>.

### 4.3.3 Connecting inputs/outputs

The input contacts of the HTC320H communication module are connected to the INPUTS terminal at the top of the module.

The output contacts of the HTC320H communication module are connected to the OUTPUTS terminal at the bottom of the module.



HTC320H inputs and outputs

Cross-section of terminals: 0.5 to 1.5 mm<sup>2</sup>.

#### Note

The 2 outputs can be used to control the motorised control accessory. An ON/OFF remote control can therefore be created via Modbus communication.



 **DANGER**

**Risk of electrical contact**

The standard HXA02xA auxiliaries are not recommended for use with the Energy circuit breaker.  
 Installing these auxiliaries in an Energy circuit breaker can result in short-circuit electrical faults between its terminals and the CIP connectors of the circuit breaker.

The assembly method for the AX/AL Energy auxiliary is described in the installation manual supplied with the accessory.

This is the procedure to follow:

	Action	Note/Illustration
1	Switch the Energy circuit breaker to the tripped position.	-
2	Open the front cover of the circuit breaker.	The front cover of the circuit breaker can only be opened in the OFF or tripped position.
3	Position the AX/AL Energy auxiliary in the specific location marked AX and AL inside the circuit breaker on the left-hand side	Use the closest position of the circuit breaker lever. See the illustration below for the installation example concerning a P250 circuit breaker.
4	Secure the auxiliary in position, confirmed by an audible click.	-
5	Insert the adapter marked ACP on the auxiliary in the connector marked ACP inside the circuit breaker on the left-hand side	Risk of damaging the ACP connector. Respect the direction of insertion for the connector: The adapter part marked ACP must be visible from the front. Avoid forcing the connector when inserting.
6	In the case of the HXS121H or HXS122H auxiliary. Route the pre-wired cables along the left-hand side cable channel of the circuit breaker provided for this purpose. If necessary, use the side support supplied with the circuit breaker to connect the cable to the side wall (see illustration below).	It is recommended to provide a connection terminal near the circuit breaker to connect the AX and AL contact wires. Please respect the wiring rules in force in the distribution boards: - Separate the routing of the power cables and the circulation of low-level signal cables - Secure the cable along the routing.
7	Close the front cover of the circuit breaker to immobilise the side support as well as the side cable routing.	

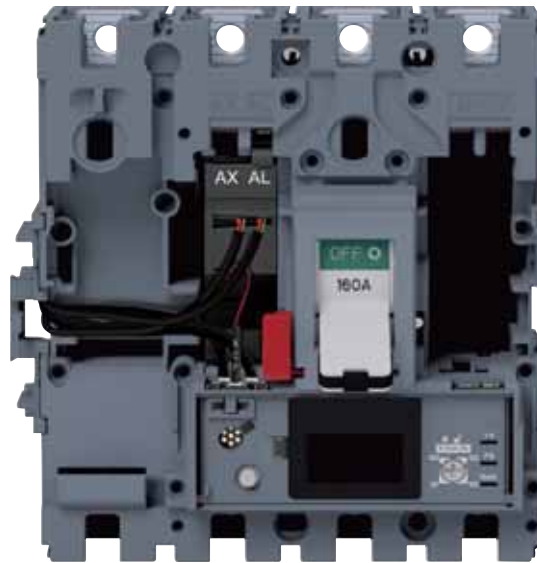

P160 AX/AL Energy connection



Energy P160 trip unit connectors



P250 AX/AL Energy connection

**4.5.1**  
**Connecting the PTA contact**

The PTA output contact is connected using the HTC130H adapter available as an option and compatible with LSI, LSIG and Energy circuit breakers.



PTA wiring

Here is the procedure to follow to connect the PTA contact:

	Action	Note/Illustration
1	Remove the transparent sticker covering the PTA connector.	The PTA connector is located on the right-hand side of the circuit breaker.
2	Insert the part of the HTC130H adapter marked PTA in the PTA connector.	Risk of damaging the PTA connector. Respect the direction of insertion for the connector: The part of the adapter marked PTA must be pointing downwards and the adapter cable must be facing the rear of the circuit breaker. Avoid forcing the connector when inserting.
3	Route the cable for the PTA adapter towards the rear of the circuit breaker. Attach the cable to the circuit breaker using adhesive tape.	It is recommended to provide a connection terminal near the circuit breaker to connect the + and - wires for the PTA adapter. The wiring of the 24 VDC circuit (max. 100 mA) may be extended from this terminal up to the 24 VDC supply terminals. + wire: Brown colour - wire: White colour Please respect the wiring rules in force in switchboards: - Separate the routing of the power cables and that of the low-level signal cables - Secure the cable along the routing.

4.5.2  
Connecting the  
OAC contact

The OAC output contact is connected using the HTC130H adapter available as an option and compatible with LSI, LSIG and Energy circuit breakers.



OAC wiring

Here is the procedure to follow to connect the OAC contact:

	Action	Note/Illustration
1	Switch the Energy circuit breaker to the OFF or tripped position.	The OAC connector is located on the right-hand side of the circuit breaker.
2	Open the front cover of the circuit breaker	The front cover of the circuit breaker can only be opened in the OFF or tripped position.
3	Insert the part of the HTC130H adapter marked OAC in the connector marked OAC inside the circuit breaker on the right-hand side	Risk of damaging the OAC connector. Respect the direction of insertion for the connector: The adapter part marked OAC must be visible from the front. Avoid forcing the connector when inserting.
4	Route the cable of the HTC130H adapter along the right-hand side cable channel of the circuit breaker provided for this purpose. If necessary, use the side support supplied with the circuit breaker to connect the cable to the side wall (see illustration above).	It is advisable to provide a connection terminal near the circuit breaker to connect the + and – wires of the HTC130H adapter. The wiring of the 24 DC circuit (max. 100 mA) may be extended from this terminal up to the 24 VDC supply terminals. + wire: Brown colour - wire: White colour Please respect the wiring rules in force in switchboards: - Separate the routing of the power cables and the circulation of low-level signal cables - Secure the cable along the routing.
5	Close the front cover of the circuit breaker to immobilise the side support as well as the side cable routing	

**4.6.1**  
**Overview of the**  
**HTD210H display**



HTD210H display

	<b>Component</b>	<b>Description</b>
①	Screen	LCD type
②	Signalling LED	Alarm – communication - Ready
③	RJ9 jack	At the rear of the display
④	Context-sensitive key	Function dependent on the menu displayed
⑤	Left/OK/Right keys	Left and Right keys to navigate to the left and right in the menus. OK key: Confirm an action.
⑥	Back key	Go back or exit menu. Return to Live mode by pressing and holding
⑦	Up/Down keys	Up and Down keys to navigate up and down the menus

Main menus of the HTD210H display



HTD210H display menus

There are 5 main menus and a pop-up menu.

	Menu	Description
①		<b>Protection:</b> This menu enables the user to view the protection parameters and to modify them if authorised to do so.
②		<b>Measurement:</b> This menu is used to view the measurement values accessible from the display.
③		<b>Alarm:</b> This menu is used to configure the alarms, the PTA output contact and the OAC output contact.
④		<b>Configuration:</b> This menu is used to set the measurement parameters and display parameters.
⑤		<b>Information:</b> This menu is used to view the status of the circuit breaker, the identification information and the alarm logs.
⑥		Pop-up <b>unlock</b> menu.

Consult the **HTD210H panel display user manual** for more information about the panel display.

**4.6.2**  
**Connecting the HTD210H display**

<b>ATTENTION</b>
<p><b>Risk of damaging the HTD210H display</b> Use of an inappropriate RJ9 lead may damage the display. Only use CIP adapters available as an option.</p>

The HTD210H panel display is connected to the Energy circuit breaker using the CIP adapter.  
The CIP adapter cable is composed of an RJ9 connector to connect to the panel display and a suitable connector to connect to the CIP connector.



HTD210H display connection

Here is the procedure to follow to connect the HTD210H display:

	<b>Action</b>	<b>Note/Illustration</b>
<b>1</b>	Switch the Energy circuit breaker to the OFF or tripped position.	-
<b>2</b>	Open the front cover of the circuit breaker	The front cover of the circuit breaker can only be opened in the OFF or tripped position.
<b>3</b>	Insert the CIP marked section for the CIP adapter in one of the connectors marked CIP inside the circuit breaker on the left-hand side	Risk of damaging the CIP connector. Respect the direction of insertion for the connector: The adapter part marked CIP must be visible from the front. Avoid forcing the connector when inserting.
<b>4</b>	Route the CIP adapter cable outside the circuit breaker until it reaches the HTD210H display.	Please respect the wiring rules in force in switchboards: - Separate the routing of the power cables and the circulation of low-level signal cables - Secure the cable along the routing.
<b>5</b>	Close the front cover of the circuit breaker to immobilise the side support as well as the side cable routing.	

4.6.3  
HTD210H display supply

The 24 VDC supply to the HTD210H display must come from an external supply.

The external 24 VDC supply is connected in two ways:

- From the communication module connection if installed.
- From the HTC140H 24 V CIP adapter connection.

To connect the communication module, see § 4.3.

To connect the CIP-24 V adapter, perform the following procedure.

	Action	Note/Illustration
1	Switch the Energy circuit breaker to the OFF or tripped position.	-
2	Open the front cover of the circuit breaker	The front cover of the circuit breaker can only be opened in the OFF or tripped position.
3	Insert the CIP marked section of the HTC140H adapter in the free CIP connector inside the circuit breaker on the left-hand side	Risk of damaging the CIP connector. Respect the direction of insertion for the connector: The adapter part marked CIP must be visible from the front. Avoid forcing the connector when inserting
4	Route the cable for the HTC140H adapter with the CIP adapter cable along the left-hand side cable channel of the circuit breaker provided for this purpose. If necessary, use the side support supplied with the circuit breaker to connect the cable to the side wall.	It is advisable to provide a 24 V connection terminal near the circuit breaker to connect the + and – wires of the HTC140H adapter. The wiring of the 24 VDC circuit may be extended from this terminal up to the 24 VDC supply terminals. + wire: Brown colour - wire: White colour Please respect the wiring rules in force in switchboards: - Separate the routing of the power cables and the circulation of low-level signal cables - Secure the cable along the routing.
5	Close the front cover of the circuit breaker to immobilise the side support as well as the side cable routing.	-



**4.6.4 Starting the HTD210H display for the first time**

The first time it is used, the display will ask you to choose the navigation language. English is the default language offered.



To change the language:













	Action	Key	Screen
1	Select another language		
2	Confirm the selection - The screen is displayed in the language chosen. - The screen will switch to Live mode		





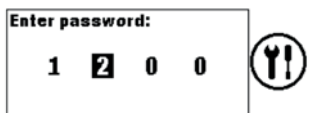

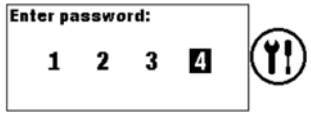
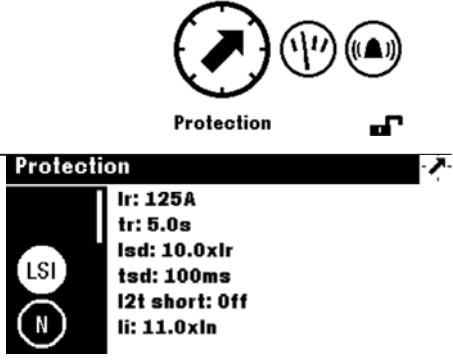



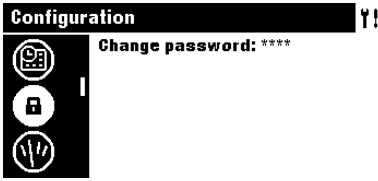

Access for modifying the circuit breaker configuration is protected by a password.

**Note**

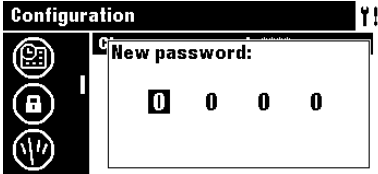
The HTD210H display is supplied with the default password: 3333. It is recommended to change the password at first start-up.

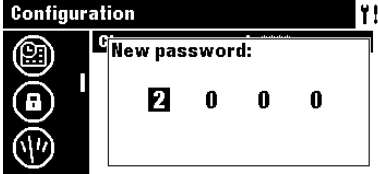
Here is the procedure to follow to change the password:

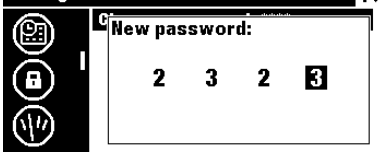
	Action	Key	Screen
1	Open the Main menu - The presence of a padlock means that the screen is locked.	 or 	
2	Open the menu for entering the password - The password must be 4 figures long. - By default: 3333.		
3	Increase/decrease the value		
4	Select the next numbers and position the values		
5	Confirm your entry Result - The screen is unlocked - The padlock symbol is open - The sub-menus are no longer locked		
			
6	If the password is incorrect, it must be entered again (Repeat from step 3)	-	

	Action	Key	Screen
7	Open the Configuration menu		 Configuration 
8	Select the sub-menu "Change the password"		
9	Confirm the selection and enter the new password		
10	Increase/decrease the value		
11	Select the next numbers and position the values		
12	Confirm the entry		

Consult the **HTD210H panel display user manual** for more information about the panel display.

#### 4.6.5 Configuration recommendations via HTD210H

Consult the **user manual for the HTD210H panel display** beforehand to read the advice and instructions for using the product.

#### Energy circuit breaker protection setting

Before using the HTD210H display to configure the Energy circuit breaker protection level, it is necessary to set the max Ir setpoint on the Energy circuit breaker.

Refer to § 4.2.3 page 81.

All the protection setting parameters can be modified from the **Protection** menu.



HTD210H panel display protection menu

#### Note

Certain protection parameters may or may not be available depending on the Energy circuit breaker model. In particular, the ZSI sub-menu is only available on an Energy P250 and above circuit breaker.

#### Setting the Energy circuit breaker measurement parameters

The measurement parameter settings can be accessed in the **Configuration** menu.



HTD210H panel display configuration menu

### Managing the alarms and output contact of the Energy circuit breaker

The settings for the alarms, and PTA and OAC output contacts can be accessed in the **Alarm** menu.



HTD210H panel display alarm menu

4.6.6 Activation of HTD210H alarms

**Alarm priorities**

The display manages the alarm warnings according to their level of priority

Priority	Actions			
	Alarm stored as an event	Stored in the list of active alarms (*)	Alarm LED flashing	Alarm notification (**)
Low	x			
Average	x	x	x	
High	x	x	x	x

**(\*) Stored in the list of active alarms:**

In Live mode only, an alarm icon is displayed above the context-sensitive key, as a context icon. If no alarm notification window is displayed, you can view it by pressing the context-sensitive key.

**(\*\*) Alarm notification:**

The alarm notification window is displayed immediately (regardless of the mode).

**Information**

When an alarm with a "Low " priority appears, it is not notified on the display.



**Alarm warnings**

High priority alarms are indicated in an alarm notification window.



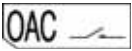

①	Alarm LED
②	Alarm notification
③	"List of active alarms" icon

**Description of an alarm notification**

Display	Description
	Trip alarm
	Custom alarm
	Appears when the active alarm has been assigned to the OAC output contact. This indicates that the OAC contact has been activated. The OAC contact can be assigned to one of the 12 custom alarms, the PTA pre-alarm or to a system alarm (internal trip unit error, trip unit temperature alarm, rupture of the neutral pole).

**Example of an alarm notification**

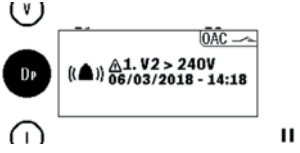
Display	Description
	<b>PTA overload pre-alarm</b> Appears when the circuit breaker load current has reached the pre-trip warning zone, defined by the PTA setting.
	<b>Manual trip test</b> A manual trip test took place on 06/03/2018 at 2:35 p.m., and was performed via the HTP610H configuration tool.
	<b>Custom alarm no.1</b> Took place on 06/03/2018 at 2:18 p.m., voltage on phase 2 V2 > 240 V

**Clearing an alarm notification**

High priority alarm notifications must be cleared.

To clear high priority alarms:

	Action	Key
1	Clear the alarm - The notification disappears.	

**Comment**

After clearing, the alarm may still be active if the cause has not been eliminated. In this case, the alarm window may be visible on the list of active alarms.

**List of active alarms**

All the descriptions of active alarms with a medium or high priority level can be accessed in the list of active alarms via the context-sensitive key.

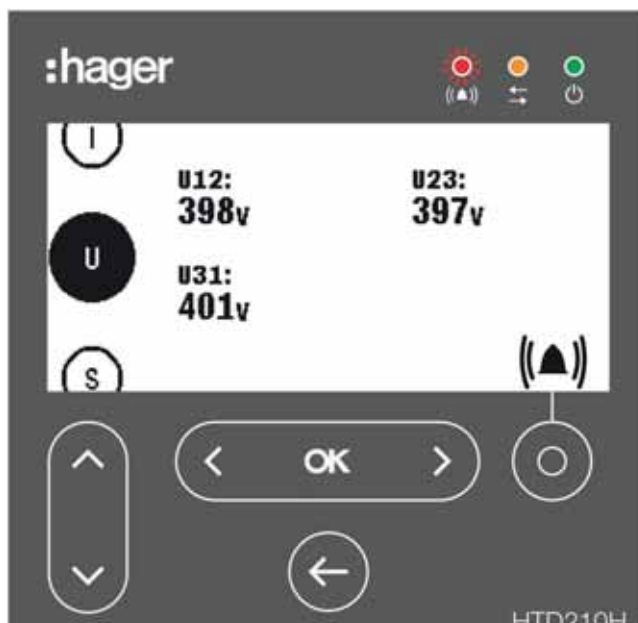

The notification windows for active alarms with a high priority level can be viewed after they have been cleared using the context-sensitive key when the Alarm icon is displayed.

In the case of active alarms with a medium priority level, it is possible to display these medium level alarms in the form of notification windows also via the context-sensitive key when the Alarm icon is displayed.

	Action	Key	Screen
1	Open the list of active alarms		
2	In the case of several active alarms: Display the previous or next notification.		



**4.7.1**  
**Preparing the HTP610H tool**

<b>ATTENTION</b>
<p>The following instructions and explanations are also described more comprehensively in the <b>HTP610H configuration tool</b> user manual. Consult the user manual for the HTP610H configuration tool beforehand to read the advice and instructions for using the tool.</p>

The HTP610H configuration tool operates autonomously thanks to an integrated rechargeable battery. Ensure that the HTP610H tool is sufficiently charged before use.

**Connecting the charger to the mains supply**



Configuration unit connected to mains supply

**Connecting to the h3+ circuit breaker**

The MIP adapter and the connection cable supplied with the tool enabling the configuration tool to be connected to the h3+ circuit breaker.



Configuration unit connection

After start-up, the configuration unit supplies the trip unit of the h3+ circuit breaker and therefore enables the embedded display of the Energy trip unit to be used.

**Connecting to the configuration server via Wi-Fi**



Configuration unit and Wi-Fi.



This is the procedure to follow in order to log into the configuration server via Wi-Fi from a multimedia tablet:

ATTENTION	
<p><b>Risk of interruption following inadvertent loss of the Wi-Fi connection</b> Use of the HTP610H configuration tool requires a stable Wi-Fi connection throughout the entire duration of use of the configuration software. Please deactivate any automatic Wi-Fi connections.</p>	

	Action	Note/Illustration
1	Start the configuration server: - Press the power button - Wait until the Power LED remains green	
2	Deactivate data roaming (cellular) on the tablet then activate the Wi-Fi	
3	Select the SSID name "HTP610H_XXXX" of your configuration tool in the list of available networks.	The SSID name is given on the label at the back of the configuration unit.
4	Enter the Wi-Fi password for the HTP610H tool: <b>MCCB_Configurator</b>	The <b>Connection</b> LED lights up orange on the configuration unit.

**Opening the circuit breaker management session**

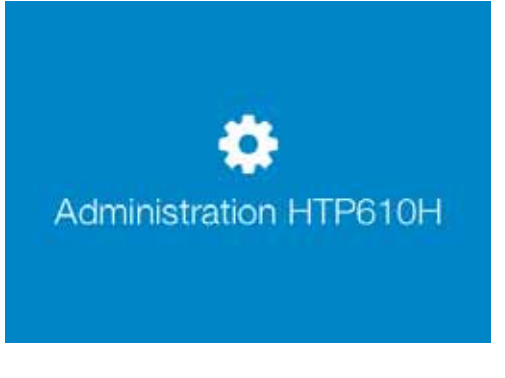
The configuration software can be accessed by two different login sessions:

Administration session	Circuit breaker management session
	
<p>The <b>Administration</b> session facilitates the following:</p> <ul style="list-style-type: none"> <li>- Manage user accounts</li> <li>- Update the configuration software</li> <li>- Generate passwords for HTD210 H and HTC310H/320H</li> <li>- Display the information concerning the version and the software licenses</li> </ul>	<p>The <b>Circuit breaker management</b> session facilitates the following:</p> <ul style="list-style-type: none"> <li>- Access the menus for managing h3+ LSnl, LSI, LSIG and Energy trip units.</li> </ul> <p><b>Note</b> Access to the test and status display menus is restricted for the LSnl, LSI and LSIG trip units.</p>

To open a circuit breaker management session from a multimedia tablet, please proceed as follows:

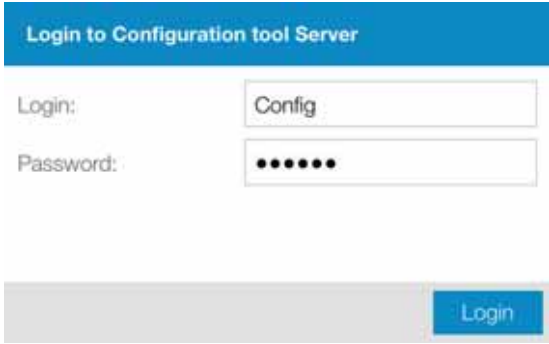
	Action	Note/Illustration
1	Open your web browser and enter the following URL address:	<a href="http://www.htp610h/index.html">http://www.htp610h/index.html</a>
2	<p>Enter your configurator login details</p> <p>By default, the following login is available: Login: <b>Config</b> Password: <b>config</b></p> <p>Click on <b>Login</b> to confirm.</p>	
3	Click on Circuit breaker or MCCB Management*	

(\*) If you cannot click on Circuit breaker Management, check that the h3+ circuit breaker is correctly connected to the configuration tool. If the problem continues, refer to the **user manual for the HTP610H configuration tool**.

**Note**

It is also possible to log in to the configuration server using an Ethernet cable from a computer. For more information, please refer to the user manual for HTP610H configuration tool.

4.7.2  
Configuration  
recommendations via  
HTP610H

**Energy circuit breaker protection setting**

Before attempting to set the Energy circuit breaker protection level with the configuration tool, it is necessary to set the max Ir setpoint on the Energy trip unit. Refer to § 4.2.3 page 81.

After having opened a circuit breaker management session, all the protection setting parameters can be modified from the **Protection Settings** menu.

**Note**

Certain protection parameters may or may not be available depending on the Energy circuit breaker model. In particular, the **ZSI** sub-menu is only available on an Energy P250 and above circuit breaker.

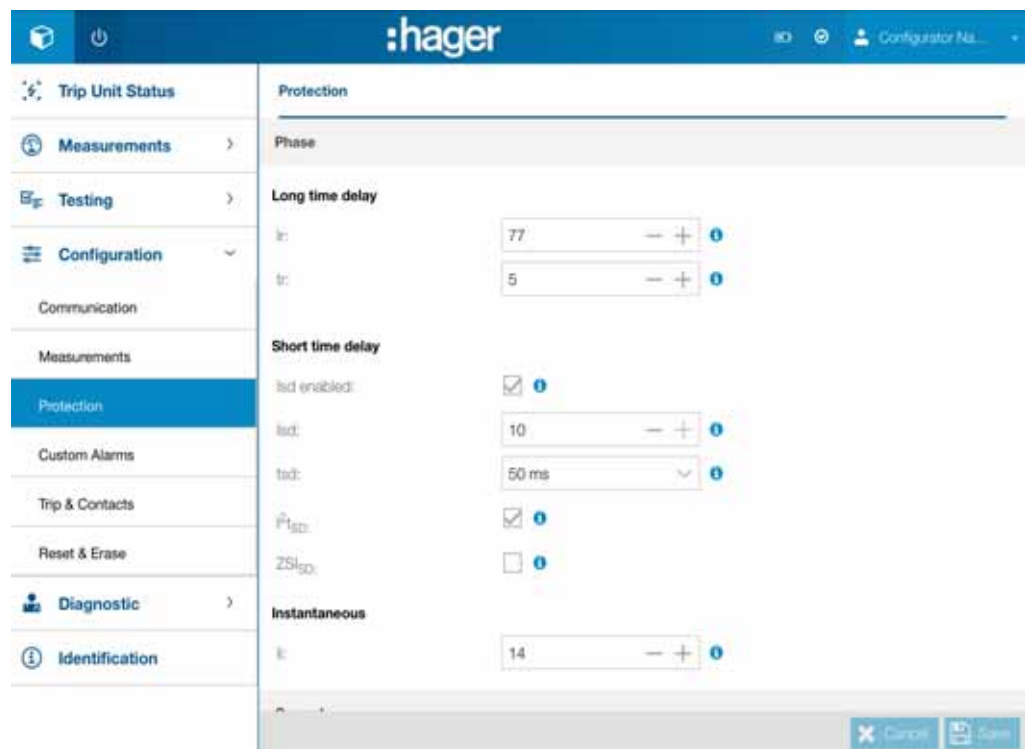

Protection settings in the HTP610H tool

**Setting the Energy circuit breaker measurement parameters via the HTP610H tool**

The Energy circuit breaker measurement parameters can be modified from the **Measurement Settings** sub-menu.

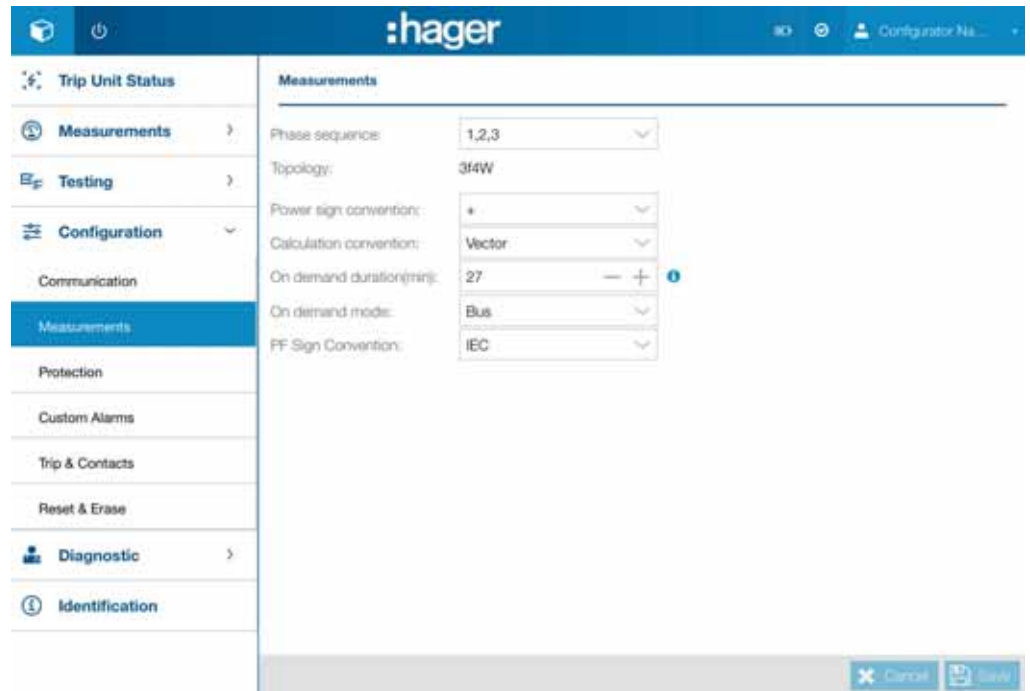

Measurement settings in the HTP610H tool

### Managing the alarms and output contacts of the Energy circuit breaker

The Energy circuit breaker measurement parameters can be modified. The settings for the alarms and PTA and OAC output contact measurement parameters can be accessed from the **Trip alarm and output contact parameters** sub-menus.

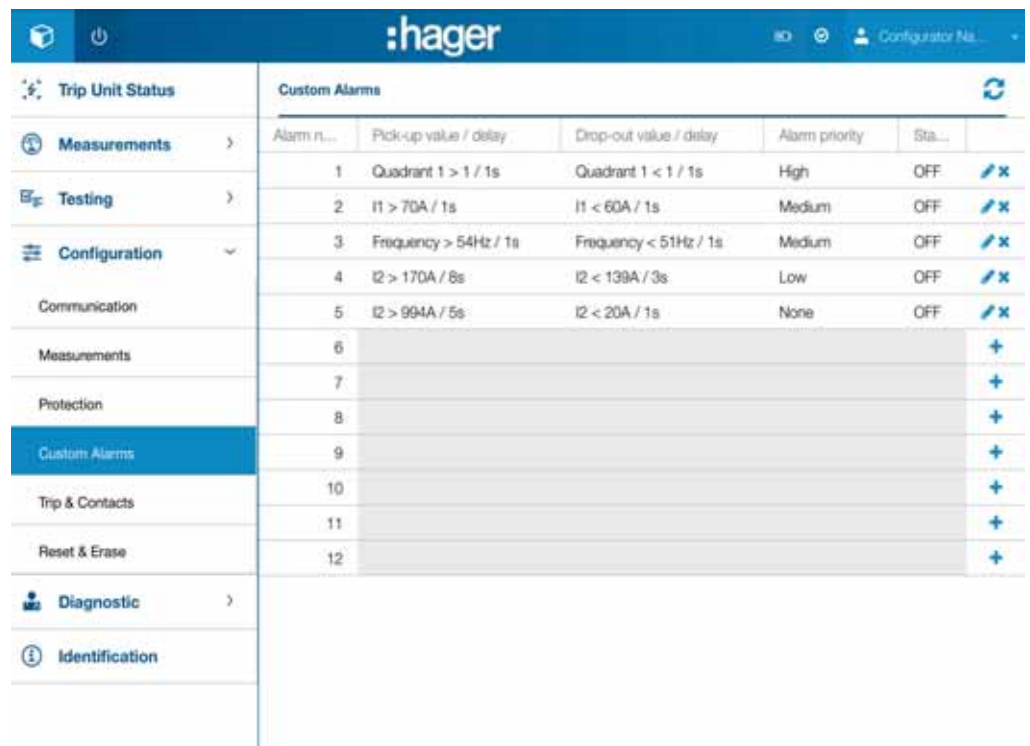

Custom alarm settings in the HTP610H tool

Consult the **user manual for the HTP610H configuration tool** beforehand to read the explanations and instructions for managing the alarms.

4.7.3  
Trip curve test via HTP610H

**DANGER**

**Risk of serious injury or danger of death.**  
Ensure that the power supply inlet upstream of the circuit breaker is cut off and isolated before performing a trip curve test.

The HTP610H configuration tool is used to test the trip curves on the h3+ LSnl, LSI, LSIG and Energy circuit breakers.

The trip test is performed from the **Test** menu.

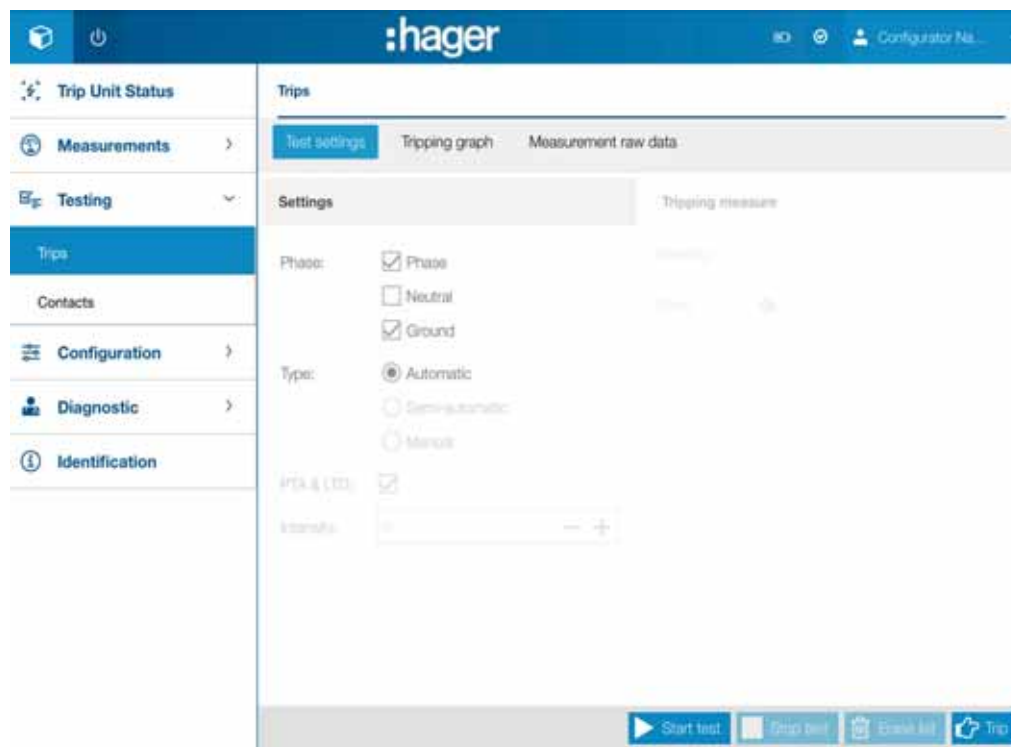

HTP610H tool test menu

Test parameter tab	Possible setting
Phase (pole to trip)	Phase - Neutral - Ground
Type	Automatic - Semi-automatic - Manual
PTA & Long time delay (threshold values)	Activated - Deactivated
Strength	Choice of test current strength for a manual type test

Type of test	Result
Automatic	All of the points on the trip curve are tested
Semi-automatic	All of the points on the trip curve are tested in stepping mode.
Manual	The configuration tool tests the strength fixed on all the threshold parameters chosen when adjusting the protection.

**4.7.4**  
**PTA and OAC contact test**  
**via HTP610H**

The HTP610H configuration tool is used to test the PTA output contact on the LSI, LSIg and Energy circuit breakers. It is also used to test the OAC output contact on the Energy circuit breaker.

The test involves forcing the closure of the PTA contact or OAC contact therefore making it possible to check the status of the offset circuit wiring on the PTA or OAC output contact.

The contacts test is performed from the **Activation of input/output contacts** sub-menu.



HTP610H tool contacts activation menu

4.8.1

Displaying information on the embedded and panel display

Information available on the embedded display

Excluding the setting values and measured values, the embedded display provides the following information from the Information (i) menu:

- Information about the last trip event by the trip unit
- AX: Number of operation cycles
- AL: Number of trips related to an electromechanical fault

Note

The information about the number of operating cycles or number of trips are only sent to the trip unit if the AX/AL Energy auxiliary accessory has been installed in the Energy circuit breaker.



OAC output alarm	Notification  OAC	OAC output contact activated
Trip alarm	Notification  LTD 299A PH.1	Indicates the type of trip and its cause: - LTD: Long time delay - STD: Short time delay - INST: Instantaneous - GROUND: Ground fault protection - TEST: Test mode via MIP connector
Trip unit temperature alarm	Notification  !	Permanent red LED or notification on Energy: Internal trip unit temperature > 105 °C
Overload alarm	 > Ir	- <b>flashing red:</b> I ≥ 105% Ir - <b>permanent red:</b> I ≥ 112% Ir
PTA overload pre-alarm	 PTA	LED 90% Ir or PTA - <b>flashing orange:</b> 90% threshold or PTA threshold reached - <b>permanent orange:</b> PTA contact activated
Trip unit status	 Ready	- <b>permanent green:</b> The trip unit is operational - <b>flashing orange:</b> Internal trip unit fault. The MCCB is considered defective and no longer guarantees the protection of the electrical installation - <b>off:</b> Trip unit not supplied correctly

Note

The pop-ups need to be cleared to access the display menus.



**Information available on the HTD210H panel display**

The measurements selected as favourites can be viewed constantly thanks to Live mode.

**Note**

The favourites on the panel display are selected and configured independently of the embedded display of the h3+ Energy circuit breaker.

The HTD210H panel display indicates the following information relating to the LEDs:



Alarm



Flashing red if a medium or high priority level alarm is activated.

Communication



Flashing yellow to indicate data traffic between the display and the Energy trip unit.

Ready



Permanent green if the display is switching on and functional.

In addition, it indicates the occurrence of high priority alarms in the form of pop-ups.

**Note**

The pop-ups need to be cleared to access the display menus when the alarms remain activated.

The panel display enables the following information to be consulted during its operating phase:

- Protection settings and other trip unit settings
- Measured values
- Alarm settings
- Alarm logs
- Identification information relating to the trip unit and display
- AX: Status of the contact and number of opening/closing cycles
- AL: Status of the contact and number of electromechanical fault trips
- Status of the PTA and OAC contacts
- Display settings

**Note**

AX and AL contact information is always sent to the display but it will only be relevant if the AX/AL Energy auxiliary accessory has been installed in the Energy circuit breaker.

**4.8.2**  
**Displaying data on the**  
**HTP610H configuration tool**

The configuration tool enables the user to view all the data required for operating, measuring and configuring the Energy circuit breaker.

The configuration interface menus provide essential data concerning the circuit breaker connected to the tool.

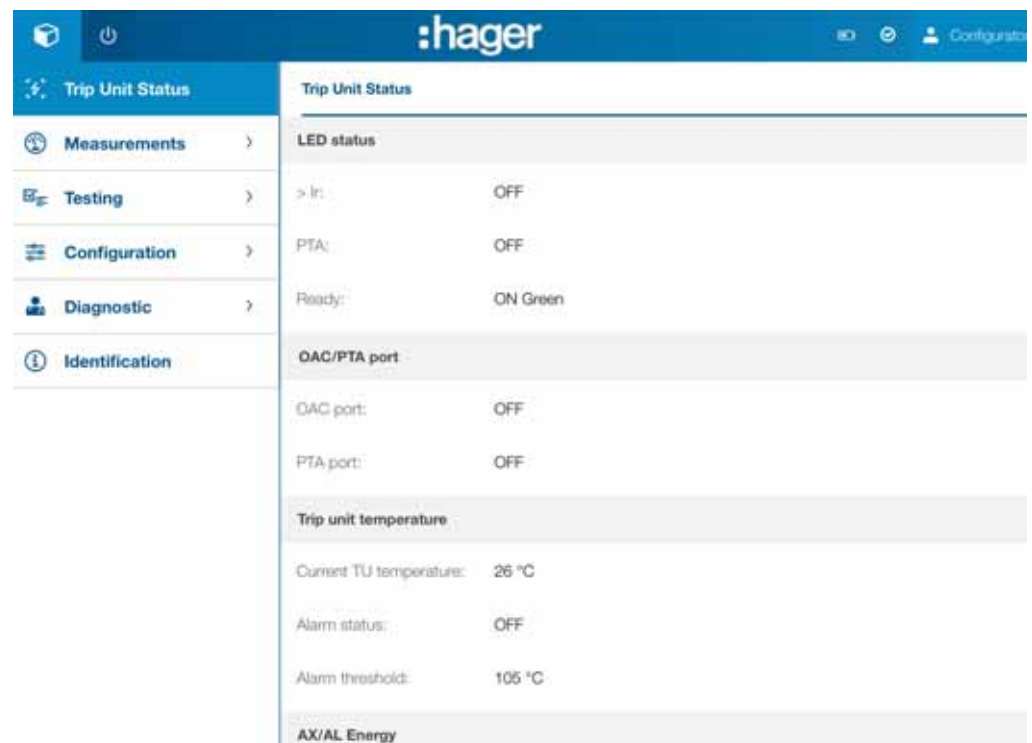

HTP610H trip unit status view

The HTP610H configuration tool makes it possible to view the following information for example:

- Trip unit LED status
- Status of the PTA and OAC contacts

- Trip unit temperature
- Protection settings and other trip unit settings
- Instantaneous and measured values (max, min, avg...)
- Test in progress
- Values tested
- Alarm settings
- Alarm logs
- Events log (changing protection settings)
- Trip unit identification information
- AX: Status of the contact and number of opening/closing cycles
- AL: Status of the contact and number of electromechanical fault trips
- ZSI: Status of the contact(s)
- Trip unit status
- Display settings

For more information about using the configuration tool, please refer to the **HTP610H h3+ configuration tool user manual**.

#### 4.8.3

**Displaying operating data  
on agardio.manager**

**See agardio.manager user manual**



# Communication via Modbus

	<b>Page</b>
<b>5.1 Modbus functionalities of the Energy circuit breaker</b>	<b>118</b>
<b>5.2 Write protection and managing Modbus passwords</b>	<b>119</b>
<b>5.3 Connecting the communication module to the Modbus network</b>	<b>120</b>
<b>5.4 Configuring the Modbus of the communication module</b>	<b>122</b>
<b>5.5 Communication with agardio.manager</b>	<b>123</b>

The Energy circuit breaker offers the option to connect to a Modbus RTU communication bus from the optional HTC310H or HTC320H communication module.

The protocol used is the Modbus RTU protocol. The HTC310H or HTC320H communication module has the advantage of automatically adjusting the number of Stop bits when adjusting the parity (see § 5.4 – Configuring the Modbus of the communication module page 122).

The communication module connects to a single Energy circuit breaker at a time. This module therefore enables the circuit breaker to operate as a Modbus slave device.

Most of the Modbus functions and standard exception codes are managed by the Energy circuit breaker.

**Note**

For more information about the Modbus functions and exception codes, please contact us.

**Note**

The table of Modbus registers is available on the Hager website.

**Risk of nuisance tripping and faulty tripping.**

Only qualified personnel are to set the protection levels remotely.  
Failure to respect these instructions may cause death, serious injuries or equipment damage.

Remote modifications made to the Modbus registers may be dangerous for personnel near the circuit breaker or may cause damage to the equipment if the protection parameters are modified.

Consequently, the remote data write commands have two protection levels:

- At the Energy circuit breaker level (see § 4.2.4 - Information about setting the data write permission - page 82)
- At the Modbus password management level

**Managing passwords**

The Modbus write access commands are protected by 4 password levels:

- Level 0 : Access to data concerning the date, time and custom fields
- Level 1 : Access to measurement configuration data
- Level 2 : Access to potentially dangerous data for the installation
- Level 3 : Access to reset level 1 and 2 passwords

Only levels 1 to 3 are password-protected:

- Level 1 : Default password "Level1"
- Level 2 : Default password "Level2"
- Level 3 : Password created using the HTP610H configuration tool

**Note**

For more information about the secure write commands, please contact us.

**ATTENTION**

**Risk of loss of Modbus data**  
Use of connection cables other than those recommended may result in functional impairments of the Modbus connection and consequently loss of data.

The communication module is connected to the Modbus wiring chain using specific cables available as an option. These cables are equipped with RJ45 connectors compatible with the connections of the communication module and agardio.manager server.

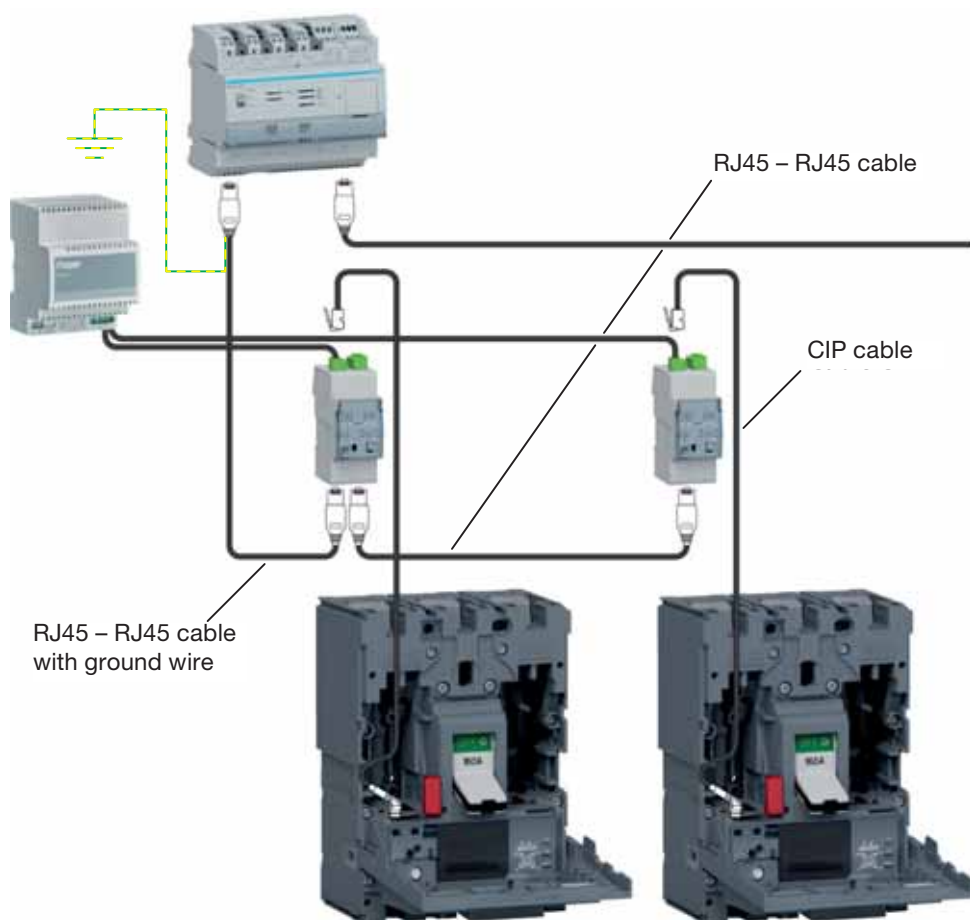

Connection to agardio.manager



Cables	Length	Reference
RJ45 – RJ45 cable	0,2 m	HTG480H
	1 m	HTG481H
	2 m	HTG482H
	5 m	HTG484H
RJ45 – RJ45 cable with ground wire	1 m	HTG471H
	2 m	HTG472H
	5 m	HTG474H
RJ45 cable – bare wire and ground wire	3 m	HTG465H
Modbus bare cable	25 m	HTG485H
CIP cable	0,50 m	HTC330H
	1,50 m	HTC340H
	3 m	HTC350H
	5 m	HTC360H
	10 m	HTC370H

The communication module is equipped with two RJ45 jacks at the bottom of the product to facilitate integration into the Modbus chain. The MODBUS 1 and MODBUS 2 jacks can be used in an inlet/outlet direction as in the case of an inlet/outlet direction of the Modbus connection chain.

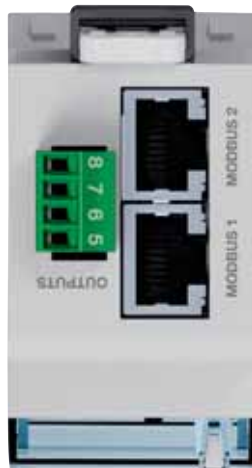

HTC320H connection terminals

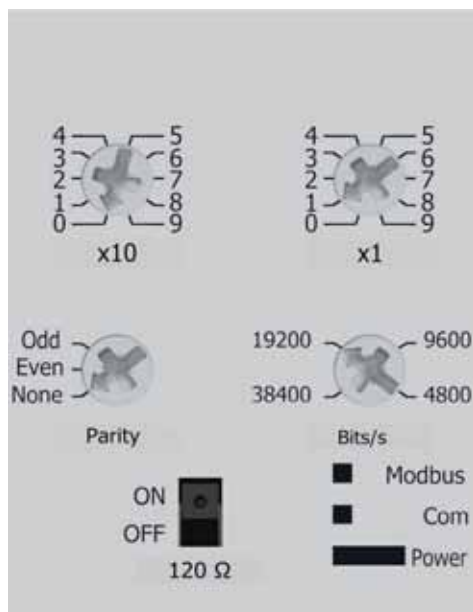

The parameters of the Modbus communication module can be adjusted on the front face using the adjustment dials and selector:

- Modbus address
- Parity
- BAUD rate
- 120Ω resistance

**Note**

The Modbus communication module has a 120 Ω resistor to integrate a terminating impedance into the Modbus chain. This resistor can be activated/deactivated by the 120Ω selector.

Modbus address setting	Default setting
1 to 99 using adjustment dials x1 and x10	1

Parity setting	Default setting
None – Odd - Even	Even

**Note**

Setting the parity includes automatically managing the automatic adjustment of the number of Stop bits.

None : No parity, 2 stop bits.

Odd : Uneven, 1 stop bit.

Even : Even, 1 stop bit.

BAUD rate setting	Default setting
4800 – 9600 – 19200 - 38400	19200

120 Ω setting	Default setting
ON - OFF	OFF

See the **agardio.manager user manual** and **HTG410H/HTG411H installation guide**



# Support

Page

---

6.1 Troubleshooting

126

---

In the event of a problem when using the h3+ system, this section provides advice on how to resolve issues.

Malfunction	Advice	If the fault continues
Ready LED off	<ul style="list-style-type: none"> <li>- Check that the current consumed by the installation is above the required threshold (see table in section 2.1.4)</li> <li>- If using an external supply, check whether the external 24 VDC supply is supplied and connected to one of the CIP connectors of the circuit breaker.</li> </ul>	Contact your Hager technical support if the fault persists.
The embedded display does not switch on	<ul style="list-style-type: none"> <li>- Check that the current consumed by the installation is above the required threshold (see table in section 2.1.4)</li> <li>- If using an external supply, check whether the external 24 VDC supply is supplied and connected to one of the CIP connectors of the circuit breaker.</li> </ul>	
Ready LED is flashing orange	<ul style="list-style-type: none"> <li>- Check the positioning of the adjustment dials,</li> <li>- On the Energy 3P trip unit, check that the neutral protection is deactivated.</li> </ul>	MCCB should be changed as it no longer guarantees the protection of the electrical installation.
"Communication error" message on the embedded display	<ul style="list-style-type: none"> <li>- Contact your Hager technical support.</li> </ul>	–
Panel display off	<ul style="list-style-type: none"> <li>- Check whether the external 24 VDC supply is supplied and connected to one of the CIP connectors of the circuit breaker.</li> <li>- Check the connection of the CIP adapter between the display and the circuit breaker.</li> <li>- Replace it if necessary.</li> </ul>	Contact your Hager technical support if the fault persists
"Communication error" message on the panel display	<ul style="list-style-type: none"> <li>- Check the connection of the CIP adapter between the display and the connection.</li> <li>- Reconnect the panel display.</li> </ul>	
Power LED for the communication module off	<ul style="list-style-type: none"> <li>- When using an external supply connected to the trip unit, check the connections between the module and the trip unit</li> <li>- When using an external supply connected to the module, check the presence of the 24 VDC at the supply output, and check the connections.</li> </ul>	–
Power LED for the communication module flashing green	<ul style="list-style-type: none"> <li>- Wait a few seconds.</li> <li>- Check the connections between the module and the circuit breaker.</li> </ul>	–
Power LED for the communication module constantly red	<ul style="list-style-type: none"> <li>- Contact your Hager technical support.</li> </ul>	Contact your Hager technical support if the fault persists
Modbus LED for the communication module constantly red	<ul style="list-style-type: none"> <li>- Check the positioning of the adjustment dials.</li> </ul>	
Modbus LED for the communication module off	<ul style="list-style-type: none"> <li>- Check the connection of the Modbus cables.</li> </ul>	

